

# **PROJECT MANUAL**

**FOR**

**Ingle Hall Flooring 2024  
H17-N150-CB**

**March 4, 2024**



**COASTAL  
CAROLINA**  
UNIVERSITY

**PO BOX 261954  
Conway, SC 29528-6054**

**TABLE OF CONTENTS**

**PROJECT NAME:** Ingle Hall Flooring 2024

---

**PROJECT NUMBER:** H17-N150-CB

---

<b><u>SECTION</u></b>	<b><u>NUMBER OF PAGES</u></b>
Table of Contents .....	2
SE-310, Invitation for Design-Bid-Build Construction Services .....	1
AIA Document A701 Instructions to Bidders South Carolina Division of Procurement Services, Office of State Engineer Version .....	14
Bid Bond (AIA A310 reference) .....	1
SE-330, Lump Sum Bid Form .....	4
AIA Document A101 Standard Form of Agreement between Owner and Contractor (Including Exhibit A) South Carolina Division of Procurement Services, Office of State Engineer Version .....	16
AIA Document A201 General Conditions of the Contract for Construction South Carolina Division of Procurement Services, Office of State Engineer Version .....	47
Attachment "A" .....	1
.....	
SE-355, Performance Bond.....	2
SE-357, Labor & Material Payment Bond .....	2
SE-380, Change Order to Design-Bid-Build Construction Contract.....	2

**TECHNICAL SPECIFICATIONS**

DIVISION 01 - GENERAL REQUIREMENTS	
SECTION 011000 - SUMMARY	3
SECTION 012500 - SUBSTITUTION PROCEDURES	3
SECTION 012600 - CONTRACT MODIFICATION PROCEDURES	2
SECTION 012900 - PAYMENT PROCEDURES	3
SECTION 013100 - PROJECT MANAGEMENT AND COORDINATION	5
SECTION 013300 - SUBMITTAL PROCEDURES	5
SECTION 017700 - CLOSEOUT PROCEDURES	4
DIVISION 09 - FINISHES	
SECTION 093013 - CERAMIC TILING	4
SECTION 096813 - TILE CARPETING	3
SITE MAPS	6

# SE-310 INVITATION FOR DESIGN-BID-BUILD CONSTRUCTION SERVICES

AGENCY: Coastal Carolina University

PROJECT NAME: Ingle Hall Flooring 2024

PROJECT NUMBER: H17-N150-CB CONSTRUCTION COST RANGE: \$190,000 to \$250,000

PROJECT LOCATION: Ingle Hall (student housing)

DESCRIPTION OF PROJECT/SERVICES: *(450 character limit)*

Demo, prepare, and replace all flooring in 16 2nd and 3rd floor 4-bedroom suites including 202, 203, 220, 221, 246, 247, 264, 265, 302, 303, 320, 321, 346, 347, 364, and 365 as well as all flooring in 128 2nd and 3rd floor bedrooms (restroom flooring is not to be replaced). Also demo, prepare, and replace flooring in lobby with specified porcelain tile.

BID/SUBMITTAL DUE DATE: 04/16/2024 TIME: 02:30 PM NUMBER OF COPIES: 1

PROJECT DELIVERY METHOD: Design-Bid-Build

AGENCY PROJECT COORDINATOR: Paula Holt

EMAIL: pholt@coastal.edu TELEPHONE: (843) 349-6562

DOCUMENTS OBTAINED FROM: https://www.coastal.edu/facilities/projects

**BID SECURITY IS REQUIRED IN AN AMOUNT NOT LESS THAN 5% OF THE BASE BID.**

**PERFORMANCE AND LABOR & MATERIAL PAYMENT BONDS:** The successful Contractor will be required to provide Performance and Labor and Material Payment Bonds, each in the amount of 100% of the Contract Price.

DOCUMENT DEPOSIT AMOUNT: \$0.00 IS DEPOSIT REFUNDABLE:  Yes  No  N/A

Bidders must obtain Bidding Documents/Plans from the above listed source(s) to be listed as an official plan holder. Bidders that rely on copies obtained from any other source do so at their own risk. All written communications with official plan holders & bidders will be via email or website posting.

Agency **WILL NOT** accept Bids sent via email.

*All questions & correspondence concerning this Invitation shall be addressed to the A/E.*

A/E NAME: " IN-HOUSE " A/E CONTACT: Paula Holt

EMAIL: pholt@coastal.edu TELEPHONE: (843) 349-6562

PRE-BID CONFERENCE:  Yes  No MANDATORY ATTENDANCE:  Yes  No

PRE-BID DATE: 04/02/2024 TIME: 11:30 AM

PRE-BID PLACE: Ingle Hall, Room 132

BID OPENING PLACE: CCU Facilities 1 Conference Room, 755 Hwy 544, Conway, SC 29526

BID DELIVERY ADDRESSES:

HAND-DELIVERY:

Attn: Paula Holt

CCU Facilities 1 Bldg.

755 Hwy 544, Conway, SC 29526

MAIL SERVICE:

Attn: Paula Holt

CCU Facilities

755 Hwy 544, Conway, SC 29526

IS PROJECT WITHIN AGENCY CONSTRUCTION CERTIFICATION?  Yes  No

APPROVED BY:



DATE: 03/22/2024

(OSE PROJECT MANAGER)

South Carolina Division of Procurement  
Services, Office of State Engineer Version of  
 AIA<sup>®</sup> Document A701<sup>™</sup> – 2018

*Instructions to Bidders*

This version of AIA Document A701<sup>™</sup>–2018 is modified by the South Carolina Division of Procurement Services, Office of State Engineer (“SCOSE”). Publication of this version of AIA Document A701–2018 does not imply the American Institute of Architects’ endorsement of any modification by SCOSE. A comparative version of AIA Document A701–2018 showing additions and deletions by SCOSE is available for review on the SCOSE Web site.

Cite this document as “AIA Document A701<sup>™</sup>– 2018, Instructions to Bidders — SCOSE Version,” or “AIA Document A701<sup>™</sup>–2018 — SCOSE Version.”

# South Carolina Division of Procurement Services, Office of State Engineer Version of AIA<sup>®</sup> Document A701<sup>™</sup> – 2018

## *Instructions to Bidders*

for the following Project:

*(Name, State Project Number, location, and detailed description)*

Ingle Hall Flooring 2024

H17-N150-CB

Ingle Hall, 160 Township Circle, Conway, SC

### THE OWNER:

*(Name, legal status, address, and other information)*

Coastal Carolina University

P.O. Box 261954

Conway, SC 29528-6054

The Owner is a Governmental Body of the State of South Carolina as defined by S.C. Code Ann. § 11-35-310.

### THE ARCHITECT:

*(Name, legal status, address, and other information)*

Coastal Carolina University

P.O. Box 261954

Conway, SC 29528-6054

This version of AIA Document A701-2018 is modified by the South Carolina Division of Procurement Services, Office of State Engineer. Publication of this version of AIA Document A701 does not imply the American Institute of Architects' endorsement of any modification by South Carolina Division of Procurement Services, Office of State Engineer. A comparative version of AIA Document A701–2018 showing additions and deletions by the South Carolina Division of Procurement Services, Office of State Engineer is available for review on South Carolina state Web site.

This document has important legal consequences. Consultation with an attorney is encouraged with respect to its completion or modification.

## TABLE OF ARTICLES

- 1 DEFINITIONS
- 2 BIDDER'S REPRESENTATIONS
- 3 BIDDING DOCUMENTS
- 4 BIDDING PROCEDURES
- 5 CONSIDERATION OF BIDS
- 6 POST-BID INFORMATION
- 7 PERFORMANCE BOND AND PAYMENT BOND
- 8 ENUMERATION OF THE PROPOSED CONTRACT DOCUMENTS

Init.

## ARTICLE 1 DEFINITIONS

§ 1.1 Bidding Documents include the Bidding Requirements and the Proposed Contract Documents. The Bidding Requirements consist of the advertisement or invitation to bid, Instructions to Bidders, supplementary instructions to bidders, the bid form, and any other bidding forms. The Proposed Contract Documents consist of the unexecuted form of Agreement between the Owner and Contractor and that Agreement's Exhibits, Conditions of the Contract (General, Supplementary and other Conditions), Drawings, Specifications, all Addenda, and all other documents enumerated in Article 8 of these Instructions.

§ 1.1.1 Any reference in this document to the Agreement between the Owner and Contractor, AIA Document A101, or some abbreviated reference thereof, shall mean the AIA Document A101-2017 Standard Form of Agreement Between Owner and Contractor, SCOSE Version. Any reference in this document to the General Conditions of the Contract for Construction, AIA Document A201, or some abbreviated reference thereof, shall mean the AIA Document A201-2017 General Conditions of the Contract for Construction, SCOSE Version.

§ 1.2 Definitions set forth in the General Conditions of the Contract for Construction, or in other Proposed Contract Documents apply to the Bidding Documents.

§ 1.3 Addenda are written or graphic instruments issued by the Architect, which, by additions, deletions, clarifications, or corrections, modify or interpret the Bidding Documents.

§ 1.4 A Bid is a complete and properly executed proposal to do the Work for the sums stipulated therein, submitted in accordance with the Bidding Documents.

§ 1.5 The Base Bid is the sum stated in the Bid for which the Bidder offers to perform the Work described in the Bidding Documents, to which Work may be added or deleted by sums stated in Alternate Bids.

§ 1.6 An Alternate Bid (or Alternate) is an amount stated in the Bid to be added to or deducted from, or that does not change, the Base Bid if the corresponding change in the Work, as described in the Bidding Documents, is accepted.

§ 1.7 A Unit Price is an amount stated in the Bid as a price per unit of measurement for materials, equipment, or services, or a portion of the Work, as described in the Bidding Documents.

§ 1.8 A Bidder is a person or entity who submits a Bid.

§ 1.9 A Sub-bidder is a person or entity who submits a bid to a Bidder for materials, equipment, or labor for a portion of the Work.

## ARTICLE 2 BIDDER'S REPRESENTATIONS

§ 2.1 By submitting a Bid, the Bidder represents that:

- .1 the Bidder has read and understands the Bidding Documents;
- .2 the Bidder understands how the Bidding Documents relate to other portions of the Project, if any, being bid concurrently or presently under construction;
- .3 the Bid complies with the Bidding Documents;
- .4 the Bidder has visited the site, become familiar with local conditions under which the Work is to be performed, has correlated the Bidder's observations with the requirements of the Proposed Contract Documents, and accepts full responsibility for any pre-bid existing conditions that would affect the Bid that could have been ascertained by a site visit. As provided in S.C. Code Ann. Reg. 19-445.2042(B), a bidder's failure to attend an advertised pre-bid conference will not excuse its responsibility for estimating properly the difficulty and cost of successfully performing the work, or for proceeding to successfully perform the work without additional expense to the State;
- .5 the Bid is based upon the materials, equipment, and systems required by the Bidding Documents without exception;
- .6 the Bidder has read and understands the provisions for liquidated damages, if any, set forth in the form of Agreement between the Owner and Contractor; and
- .7 the Bidder understands that it may be required to accept payment by electronic funds transfer (EFT).

### § 2.2 Certification of Independent Price Determination

§ 2.2.1 GIVING FALSE, MISLEADING, OR INCOMPLETE INFORMATION ON THIS CERTIFICATION MAY RENDER YOU SUBJECT TO PROSECUTION UNDER SC CODE OF LAWS §16-9-10 AND OTHER APPLICABLE LAWS.

§ 2.2.2 By submitting a Bid, the Bidder certifies that:

- .1 The prices in this Bid have been arrived at independently, without, for the purpose of restricting competition, any consultation, communication, or agreement with any other bidder or competitor relating to:
  - .1 those prices;
  - .2 the intention to submit a Bid; or
  - .3 the methods or factors used to calculate the prices offered.
- .2 The prices in this Bid have not been and will not be knowingly disclosed by the Bidder, directly or indirectly, to any other bidder or competitor before bid opening (in the case of a sealed bid solicitation) or contract award (in the case of a negotiated solicitation) unless otherwise required by law; and
- .3 No attempt has been made or will be made by the Bidder to induce any other concern to submit or not to submit a Bid for the purpose of restricting competition.

§ 2.2.3 Each signature on the Bid is considered to be a certification by the signatory that the signatory:

- .1 Is the person in the Bidder's organization responsible for determining the prices being offered in this Bid, and that the signatory has not participated and will not participate in any action contrary to Section 2.2.2 of this certification; or
- .2 Has been authorized, in writing, to act as agent for the Bidder's principals in certifying that those principals have not participated, and will not participate in any action contrary to Section 2.2.2 of this certification [As used in this subdivision, the term "principals" means the person(s) in the Bidder's organization responsible for determining the prices offered in this Bid];
- .3 As an authorized agent, does certify that the principals referenced in Section 2.2.3.2 of this certification have not participated, and will not participate, in any action contrary to Section 2.2.2 of this certification; and
- .4 As an agent, has not personally participated, and will not participate, in any action contrary to Section 2.2.2 of this certification.

§ 2.2.4 If the Bidder deletes or modifies Section 2.2.2.2 of this certification, the Bidder must furnish with its offer a signed statement setting forth in detail the circumstances of the disclosure.

#### § 2.2.5 Drug Free Workplace Certification

By submitting a Bid, the Bidder certifies that, if awarded a contract, Bidder will comply with all applicable provisions of The Drug-free Workplace Act, S.C. Code Ann. 44-107-10, et seq.

#### § 2.2.6 Certification Regarding Debarment and Other Responsibility Matters

§ 2.2.6.1 By submitting a Bid, Bidder certifies, to the best of its knowledge and belief, that:

- .1 Bidder and/or any of its Principals-
  - .1 Are not presently debarred, suspended, proposed for debarment, or declared ineligible for the award of contracts by any state or federal agency;
  - .2 Have not, within a three-year period preceding this Bid, been convicted of or had a civil judgment rendered against them for: commission of fraud or a criminal offense in connection with obtaining, attempting to obtain, or performing a public (Federal, state, or local) contract or subcontract; violation of Federal or state antitrust statutes relating to the submission of bids; or commission of embezzlement, theft, forgery, bribery, falsification or destruction of records, making false statements, tax evasion, or receiving stolen property; and
  - .3 Are not presently indicted for, or otherwise criminally or civilly charged by a governmental entity with, commission of any of the offenses enumerated in Section 2.2.6.1.1.2 of this provision.
- .2 Bidder has not, within a three-year period preceding this Bid, had one or more contracts terminated for default by any public (Federal, state, or local) entity.
- .3 "Principals," for the purposes of this certification, means officers; directors; owners; partners; and, persons having primary management or supervisory responsibilities within a business entity (e.g., general manager; plant manager; head of a subsidiary, division, or business segment, and similar positions).

§ 2.2.6.2 Bidder shall provide immediate written notice to the Procurement Officer if, at any time prior to contract award, Bidder learns that its certification was erroneous when submitted or has become erroneous by reason of changed circumstances.



§ 2.2.6.3 If Bidder is unable to certify the representations stated in Section 2.2.6.1, Bidder must submit a written explanation regarding its inability to make the certification. The certification will be considered in connection with a review of the Bidder's responsibility. Failure of the Bidder to furnish additional information as requested by the Procurement Officer may render the Bidder non-responsible.

§ 2.2.6.4 Nothing contained in the foregoing shall be construed to require establishment of a system of records in order to render, in good faith, the certification required by Section 2.2.6.1 of this provision. The knowledge and information of a Bidder is not required to exceed that which is normally possessed by a prudent person in the ordinary course of business dealings.

§ 2.2.6.5 The certification in Section 2.2.6.1 of this provision is a material representation of fact upon which reliance was placed when making award. If it is later determined that the Bidder knowingly or in bad faith rendered an erroneous certification, in addition to other remedies available to the State, the Procurement Officer may terminate the contract resulting from this solicitation for default.

### § 2.2.7 Ethics Certificate

By submitting a Bid, the Bidder certifies that the Bidder has and will comply with, and has not, and will not, induce a person to violate Title 8, Chapter 13 of the SC Code of Laws, as amended (Ethics Act). The following statutes require special attention: S.C. Code Ann. §8-13-700, regarding use of official position for financial gain; S.C. Code Ann. §8-13-705, regarding gifts to influence action of public official; S.C. Code Ann. §8-13-720, regarding offering money for advice or assistance of public official; S.C. Code Ann. §8-13-755 and §8-13-760, regarding restrictions on employment by former public official; S.C. Code Ann. §8-13-775, prohibiting public official with economic interests from acting on contracts; S.C. Code Ann. §8-13-790, regarding recovery of kickbacks; S.C. Code Ann. §8-13-1150, regarding statements to be filed by consultants; and S.C. Code Ann. §8-13-1342, regarding restrictions on contributions by contractor to candidate who participated in awarding of contract. The State may rescind any contract and recover all amounts expended as a result of any action taken in violation of this provision. If the contractor participates, directly or indirectly, in the evaluation or award of public contracts, including without limitation, change orders or task orders regarding a public contract, the contractor shall, if required by law to file such a statement, provide the statement required by S.C. Code Ann. §8-13-1150 to the Procurement Officer at the same time the law requires the statement to be filed.

### § 2.2.8 Restrictions Applicable To Bidders & Gifts

Violation of these restrictions may result in disqualification of your Bid, suspension or debarment, and may constitute a violation of the state Ethics Act.

§ 2.2.8.1 After issuance of the solicitation, Bidder agrees not to discuss this procurement activity in any way with the Owner or its employees, agents or officials. All communications must be solely with the Procurement Officer. This restriction may be lifted by express written permission from the Procurement Officer. This restriction expires once a contract has been formed.

§ 2.2.8.2 Unless otherwise approved in writing by the Procurement Officer, Bidder agrees not to give anything to the Owner, any affiliated organizations, or the employees, agents or officials of either, prior to award.

§ 2.2.8.3 Bidder acknowledges that the policy of the State is that a governmental body should not accept or solicit a gift, directly or indirectly, from a donor if the governmental body has reason to believe the donor has or is seeking to obtain contractual or other business or financial relationships with the governmental body. SC Regulation 19-445.2165(C) broadly defines the term donor.

### § 2.2.9 Open Trade Representation

By submitting a Bid, the Bidder represents that Bidder is not currently engaged in the boycott of a person or an entity based in or doing business with a jurisdiction with whom South Carolina can enjoy open trade, as defined in S.C. Code Ann. §11-35-5300.

## ARTICLE 3 BIDDING DOCUMENTS

### § 3.1 Distribution

§ 3.1.1 Bidders shall obtain complete Bidding Documents from the issuing office designated in the advertisement or invitation to bid, for the deposit sum, if any, stated therein.

§ 3.1.2 Any required deposit shall be refunded to all plan holders who return the paper Bidding Documents in good condition within ten (10) days after receipt of Bids. The cost to replace missing or damaged paper documents will be deducted from the deposit. A Bidder receiving a Contract award may retain the paper Bidding Documents, and the Bidder's deposit will be refunded.

### § 3.1.3 Reserved

§ 3.1.4 Bidders shall use complete Bidding Documents in preparing Bids. Neither the Owner nor Architect assumes responsibility for errors or misinterpretations resulting from the use of incomplete Bidding Documents.

§ 3.1.5 The Bidding Documents will be available for the sole purpose of obtaining Bids on the Work. No license or grant of use is conferred by distribution of the Bidding Documents.

§ 3.1.6 All persons obtaining Bidding Documents from the issuing office designated in the advertisement shall provide that office with Bidder's contact information to include the Bidder's name, telephone number, mailing address, and email address.

## § 3.2 Modification or Interpretation of Bidding Documents

§ 3.2.1 The Bidder shall carefully study the Bidding Documents, shall examine the site and local conditions, and shall notify the Architect of errors, inconsistencies, or ambiguities discovered and request clarification or interpretation pursuant to Section 3.2.2. Failure to do so will be at the Bidder's risk. Bidder assumes responsibility for any patent ambiguity that Bidder does not bring to the Architect's attention prior to Bid Opening.

§ 3.2.2 Requests for clarification or interpretation of the Bidding Documents shall be submitted by the Bidder in writing and shall be received by the Architect at least ten (10) days prior to the date for receipt of Bids.

§ 3.2.3 Modifications, corrections, changes, and interpretations of the Bidding Documents shall be made by Addendum. Modifications, corrections, changes, and interpretations of the Bidding Documents made in any other manner shall not be binding, and Bidders shall not rely upon them.

§ 3.2.4 As provided in S.C. Code Ann. Reg. 19-445.2042(B), nothing stated at the Pre-bid conference shall change the Bidding Documents unless a change is made by Addendum.

## § 3.3 Substitutions

§ 3.3.1 The materials, products, and equipment described in the Bidding Documents establish a standard of required function, dimension, appearance, and quality to be met by any proposed substitution. Where "brand name or equal" is used in the Bidding Documents, the listing description is not intended to limit or restrict competition.

### § 3.3.2 Substitution Process

§ 3.3.2.1 Written requests for substitutions shall be received by the Architect at least ten (10) days prior to the date for receipt of Bids. Requests shall be submitted in the same manner as that established for submitting clarifications and interpretations in Section 3.2.2.

§ 3.3.2.2 Bidders shall submit substitution requests on a Substitution Request Form if one is provided in the Bidding Documents.

§ 3.3.2.3 If a Substitution Request Form is not provided, requests shall include (1) the name of the material or equipment specified in the Bidding Documents; (2) the reason for the requested substitution; (3) a complete description of the proposed substitution including the name of the material or equipment proposed as the substitute, performance and test data, and relevant drawings; and (4) any other information necessary for an evaluation. The request shall include a statement setting forth changes in other materials, equipment, or other portions of the Work, including changes in the work of other contracts or the impact on any Project Certifications (such as LEED), that will result from incorporation of the proposed substitution.

§ 3.3.2.4 No request to substitute materials, products, or equipment for materials, products, or equipment described in the Bidding Documents and no request for addition of a manufacturer or supplier to a list of approved manufacturers or suppliers in the Bidding Documents will be considered prior to receipt of Bids unless written request for approval has been received by the Architect at least ten (10) days prior to the date for receipt of Bids established in the invitation to bid.

Init.

Any subsequent extension of the date for receipt of Bids by addendum shall not extend the date for receipt of such requests unless the addendum so specifies. A statement setting forth changes in other materials, equipment or other portions of the Work, including changes in the Work of other contracts that incorporation of the proposed substitution would require, shall be included.

§ 3.3.3 The burden of proof of the merit of the proposed substitution is upon the proposer. The Architect's decision of approval or disapproval of a proposed substitution shall be final.

§ 3.3.4 If the Architect approves a proposed substitution prior to receipt of Bids, such approval shall be set forth in an Addendum. Approvals made in any other manner shall not be binding, and Bidders shall not rely upon them.

§ 3.3.5 No substitutions will be considered after the Contract award unless specifically provided for in the Contract Documents.

#### § 3.4 Addenda

§ 3.4.1 Addenda will be transmitted to Bidders known by the issuing office to have received complete Bidding Documents.

§ 3.4.2 Addenda will be available where Bidding Documents are on file.

§ 3.4.3 Addenda will be issued at least five (5) business days before the day of the Bid Opening, except an Addendum withdrawing the request for Bids or one which includes postponement of the date for receipt of Bids. A business day runs from midnight to midnight and excludes weekends and state and federal holidays.

§ 3.4.4 Prior to submitting a Bid, each Bidder shall ascertain that the Bidder has received all Addenda issued, and the Bidder shall acknowledge their receipt in the Bid.

§ 3.4.5 When the date for receipt of Bids is to be postponed and there is insufficient time to issue an Addendum prior to the original Bid Date, the Owner will notify prospective Bidders by telephone or other appropriate means with immediate follow up with an Addendum. This Addendum will verify the postponement of the original Bid Date and establish a new Bid Date. The new Bid Date will be no earlier than the fifth (5th) business day after the date of issuance of the Addendum postponing the original Bid Date.

§ 3.4.6 If an emergency or unanticipated event interrupts normal government processes so that Bids cannot be received at the government office designated for receipt of Bids by the exact time specified in the solicitation, the time specified for receipt of Bids will be deemed to be extended to the same time of day specified in the solicitation on the first work day on which normal government processes resume. In lieu of an automatic extension, an Addendum may be issued to reschedule Bid Opening. If state offices are closed in the county in which Bids are to be received at the time a pre-bid or pre-proposal conference is scheduled, an Addendum will be issued to reschedule the conference. Bidders shall visit <https://www.scemd.org/closings/> for information concerning closings.

### ARTICLE 4 BIDDING PROCEDURES

#### § 4.1 Preparation of Bids

§ 4.1.1 Bids shall be submitted on the forms included with or identified in the Bidding Documents.

§ 4.1.2 All blanks on the Bid Form shall be legibly executed. Paper bid forms shall be executed in a non-erasable medium.

§ 4.1.3 Sums shall be expressed in numbers.

§ 4.1.4 Interlineations, alterations and erasures must be initialed by the signer of the Bid. Bidder shall not make stipulations or qualify his Bid in any manner not permitted on the Bid Form. An incomplete Bid or information not requested that is written on or attached to the Bid Form that could be considered a qualification of the Bid, may be cause for rejection of the Bid.

§ 4.1.5 All requested Alternates shall be bid. The failure of the Bidder to indicate a price for an Alternate shall render the Bid non-responsive. Indicate the change to the Base Bid by entering the dollar amount and marking, as appropriate, the box for "ADD TO" or "DEDUCT FROM". If no change in the Base Bid is required, enter "ZERO" or "No Change".

Init.

§ 4.1.6 Pursuant to S.C. Code Ann. § 11-35-3020(b)(i), as amended, Section 7 of the Bid Form sets forth a list of proposed subcontractors for which the Bidder is required to identify those subcontractors the Bidder will use to perform the work listed. Bidder must follow the instructions in the Bid Form for filling out this section of the Bid Form. Failure to properly fill out Section 7 may result in rejection of Bidder's bid as non-responsive.

§ 4.1.7 Contractors and subcontractors listed in Section 7 of the Bid Form who are required by the South Carolina Code of Laws to be licensed, must be licensed as required by law at the time of bidding.

§ 4.1.8 Each copy of the Bid shall state the legal name and legal status of the Bidder. Each copy of the Bid shall be signed by the person or persons legally authorized to bind the Bidder to a contract.

§ 4.1.9 A Bidder shall incur all costs associated with the preparation of its Bid.

## § 4.2 Bid Security

§ 4.2.1 If required by the invitation to bid, each Bid shall be accompanied by a bid security in an amount of not less than five percent of the Base Bid. The bid security shall be a bid bond or a certified cashier's check.

§ 4.2.2 The Bidder pledges to enter into a Contract with the Owner on the terms stated in the Bid and shall, if required, furnish bonds covering the faithful performance of the Contract and payment of all obligations arising thereunder. Should the Bidder refuse to enter into such Contract or fail to furnish such bonds if required, the amount of the bid security shall be forfeited to the Owner as liquidated damages, not as a penalty.

§ 4.2.3 If a surety bond is required as bid security, it shall be written on AIA Document A310™, Bid Bond and the attorney-in-fact who executes the bond on behalf of the surety shall affix to the bond a certified and current copy of an acceptable power of attorney. The Bid Bond shall:

- .1 be issued by a surety company licensed to do business in South Carolina;
- .2 be issued by a surety company having, at a minimum, a "Best Rating" of "A" as stated in the most current publication of "Best's Key Rating Guide, Property-Casualty", which company shows a financial strength rating of at least five (5) times the contract price.
- .3 be enclosed in the bid envelope at the time of Bid Opening, either in paper copy or as an electronic bid bond authorization number provided on the Bid Form and issued by a firm or organization authorized by the surety to receive, authenticate and issue binding electronic bid bonds on behalf the surety.

§ 4.2.4 The Owner will have the right to retain the bid security of Bidders to whom an award is being considered until either (a) the Contract has been executed and performance and payment bonds, if required, have been furnished; (b) the specified time has elapsed so that Bids may be withdrawn; or (c) all Bids have been rejected.

§ 4.2.5 By submitting a Bid Bond via an electronic bid bond authorization number on the Bid Form and signing the Bid Form, the Bidder certifies that an electronic bid bond has been executed by a Surety meeting the standards required by the Bidding Documents and the Bidder and Surety are firmly bound unto the State of South Carolina under the conditions provided in this Section 4.2.

## § 4.3 Submission of Bids

§ 4.3.1 A Bidder shall submit its Bid as indicated below:

§ 4.3.2 All paper copies of the Bid, the bid security, and any other documents required to be submitted with the Bid shall be enclosed in a sealed opaque envelope. The envelope shall, unless hand delivered by the Bidder, be addressed to the Owner's designated purchasing office as shown in the invitation to bid. The envelope shall be identified with the Project name, the Bidder's name and address, and, if applicable, the designated portion of the Work for which the Bid is submitted. If the Bid is sent by mail, or special delivery service (UPS, Federal Express, etc.), the sealed envelope shall be labelled "SEALED BID ENCLOSED" on the face thereof. Bidders hand delivering their Bids shall deliver Bids to the place of the Bid Opening as shown in the invitation for bids. Whether or not Bidders attend the Bid Opening, they shall give their Bids to the Owner's Procurement Officer or his/her designee as shown in the invitation to bid prior to the time of the Bid Opening.

§ 4.3.3 Bids shall be submitted by the date and time and at the place indicated in the invitation to bid. Bids submitted after the date and time for receipt of Bids, or at an incorrect place, will not be accepted.

§ 4.3.4 The Bidder shall assume full responsibility for timely delivery at the location designated for receipt of Bids.

§ 4.3.5 A Bid submitted by any method other than as provided in this Section 4.3 will not be accepted. Oral, telephonic, telegraphic, facsimile or other electronically transmitted bids will not be considered.

§ 4.3.6 The official time for receipt of Bids will be determined by reference to the clock designated by the Owner's Procurement Officer or his/her designee. The Procurement Officer conducting the Bid Opening will determine and announce that the deadline has arrived and no further Bids or bid modifications will be accepted. All Bids and bid modifications in the possession of the Procurement Officer at the time the announcement is completed will be timely, whether or not the bid envelope has been date/time stamped or otherwise marked by the Procurement Officer.

#### § 4.4 Modification or Withdrawal of Bid

§ 4.4.1 Prior to the date and time designated for receipt of Bids, a Bidder may submit a new Bid to replace a Bid previously submitted, or withdraw its Bid entirely, by notice to the party designated to receive the Bids. Such notice shall be received and duly recorded by the receiving party on or before the date and time set for receipt of Bids. The receiving party shall verify that replaced or withdrawn Bids are removed from the other submitted Bids and not considered. Notice of submission of a replacement Bid or withdrawal of a Bid shall be worded so as not to reveal the amount of the original Bid.

§ 4.4.2 Withdrawn Bids may be resubmitted up to the date and time designated for the receipt of Bids in the same format as that established in Section 4.3, provided they fully conform with these Instructions to Bidders. Bid security shall be in an amount sufficient for the Bid as resubmitted.

### ARTICLE 5 CONSIDERATION OF BIDS

#### § 5.1 Opening of Bids

Bids received on time will be publicly opened and read aloud. The Owner will not read aloud Bids that the Owner determines, at the time of opening, to be non-responsive.

§ 5.1.1 At Bid Opening, the Owner will announce the date and location of the posting of the Notice of Intend to Award. If the Owner determines to award the Project, the Owner will, after posting a Notice of Intend to Award, send a copy of the Notice to all Bidders.

§ 5.1.2 The Owner will send a copy of the final Bid Tabulation to all Bidders within ten (10) working days of the Bid Opening.

§ 5.1.3 If only one Bid is received, the Owner will open and consider the Bid.

#### § 5.2 Rejection of Bids

§ 5.2.1 The Owner shall have the right to reject any or all Bids. A Bid not accompanied by a required bid security or by other data required by the Bidding Documents, or a Bid which is in any way incomplete or irregular is subject to rejection.

§ 5.2.2 The reasons for which the Owner will reject Bids include, but are not limited to:

- .1 Failure by a Bidder to be represented at a Mandatory Pre-Bid Conference or site visit;
- .2 Failure to deliver the Bid on time;
- .3 Failure to comply with Bid Security requirements, except as expressly allowed by law;
- .4 Listing an invalid electronic Bid Bond authorization number on the Bid Form;
- .5 Failure to Bid an Alternate, except as expressly allowed by law;
- .6 Failure to list qualified subcontractors as required by law;
- .7 Showing any material modification(s) or exception(s) qualifying the Bid;
- .8 Faxing a Bid directly to the Owner or Owner's representative; or
- .9 Failure to include a properly executed Power-of-Attorney with the Bid Bond.

§ 5.2.3 The Owner may reject a Bid as nonresponsive if the prices bid are materially unbalanced between line items or sub-line items. A Bid is materially unbalanced when it is based on prices significantly less than cost for some work and prices which are significantly overstated in relation to cost for other work, and if there is a reasonable doubt that the Bid



will result in the lowest overall cost to the Owner even though it may be the low evaluated Bid, or if it is so unbalanced as to be tantamount to allowing an advance payment.

### § 5.3 Acceptance of Bid (Award)

§ 5.3.1 It is the intent of the Owner to award a Contract to the lowest responsive and responsible Bidder, provided the Bid has been submitted in accordance with the requirements of the Bidding Documents and does not exceed available funds. The Owner shall have the right to waive informalities and irregularities in a Bid received and to accept the Bid which, in the Owner's judgment, is in the Owner's best interests.

§ 5.3.2 The Owner shall have the right to accept Alternates in any order or combination, unless otherwise specifically provided in the Bidding Documents, and to determine the lowest responsive and responsible Bidder on the basis of the sum of the Base Bid and Alternates accepted.

## ARTICLE 6 POST-BID INFORMATION

### § 6.1 Contractor's Responsibility

Owner will make a determination of Bidder's responsibility before awarding a contract. Bidder shall provide all information and documentation requested by the Owner to support the Owner's evaluation of responsibility. Failure of Bidder to provide requested information is cause for the Owner, at its option, to determine the Bidder to be non-responsible.

### § 6.2 Reserved

### § 6.3 Submittals

§ 6.3.1 After notification of selection for the award of the Contract, the Bidder shall, as soon as practicable or as stipulated in the Bidding Documents, submit in writing to the Owner through the Architect:

- .1 a designation of the Work to be performed with the Bidder's own forces;
- .2 names of the principal products and systems proposed for the Work and the manufacturers and suppliers of each; and
- .3 names of persons or entities (including those who are to furnish materials or equipment fabricated to a special design) proposed for the principal portions of the Work.

### § 6.4 Posting of Intent To Award

The Notice of Intent to Award will be posted at the following location:

**Room or Area of Posting:**

**Building Where Posted:**

**Address of Building:**

**WEB site address (if applicable):**

**Posting date will be announced at Bid Opening.** In addition to posting the Notice, the Owner will promptly send all responsive Bidders a copy of the Notice of Intent to Award and the final bid tabulation

### § 6.5 Protest of Solicitation or Award

§ 6.5.1 If you are aggrieved in connection with the solicitation or award of a contract, you may be entitled to protest, but only as provided in S.C. Code Ann. § 11-35-4210. To protest a solicitation, you must submit a protest within fifteen (15) days of the date the applicable solicitation document is issued. To protest an award, you must (i) submit notice of your intent to protest within seven (7) business days of the date the award notice is posted, and (ii) submit your actual protest within fifteen (15) days of the date the award notice is posted. Days are calculated as provided in Section 11-35-310(13). Both protests and notices of intent to protest must be in writing and must be received by the State Engineer within the time provided. The grounds of the protest and the relief requested must be set forth with enough particularity to give notice of the issues to be decided.

§ 6.5.2 Any protest must be addressed to the CPO, Office of State Engineer, and submitted in writing:

- .1 by email to [protest-ose@mmo.sc.gov](mailto:protest-ose@mmo.sc.gov),
- .2 by facsimile at 803-737-0639, or
- .3 by post or delivery to 1201 Main Street, Suite 600, Columbia, SC 29201.

By submitting a protest to the foregoing email address, you (and any person acting on your behalf) consent to receive communications regarding your protest (and any related protests) at the e-mail address from which you sent your protest.

**ARTICLE 7 PERFORMANCE BOND AND PAYMENT BOND**

**§ 7.1 Bond Requirements**

§ 7.1.1 If stipulated in the Bidding Documents, the Bidder shall furnish bonds covering the faithful performance of the Contract and payment of all obligations arising thereunder.

§ 7.1.2 If the furnishing of such bonds is stipulated in the Bidding Documents, the cost shall be included in the Bid.

§ 7.1.3 The Bidder shall provide surety bonds from a company or companies lawfully authorized to issue surety bonds in the state of South Carolina.

§ 7.1.4 Unless otherwise indicated below, the Penal Sum of the Payment and Performance Bonds shall be the amount of 100% of the Contract Sum.

**§ 7.2 Time of Delivery of Contract, Certificates of Insurance, and Form of Bonds**

§ 7.2.1 Following expiration of the protest period, the Owner will forward the Contract for Construction to the Bidder for signature. The Bidder shall return the fully executed Contract for Construction to the Owner within seven (7) days. The Bidder shall deliver the required bonds and certificate of insurance to the Owner not later than three (3) days following the date of execution of the Contract. Failure to deliver these documents as required shall entitle the Owner to consider the Bidder’s failure as a refusal to enter into a contract in accordance with the terms and conditions of the Bidder’s Bid and to make claim on the Bid Security for re-procurement cost.

§ 7.2.2 Unless otherwise provided, the bonds shall be written on the Performance Bond and Payment Bond forms included in the Bid Documents.

§ 7.2.3 The bonds shall be dated on or after the date of the Contract.

§ 7.2.4 The Bidder shall require the attorney-in-fact who executes the required bonds on behalf of the surety to affix to the bond a certified and current copy of the power of attorney.

**ARTICLE 8 ENUMERATION OF THE PROPOSED CONTRACT DOCUMENTS**

§ 8.1 Copies of the proposed Contract Documents have been made available to the Bidder and consist of the following documents:

- .1 AIA Document A101™–2017, Standard Form of Agreement Between Owner and Contractor, SCOSE Version.
- .2 AIA Document A101™–2017, Exhibit A, Insurance and Bonds, SCOSE Version.
- .3 AIA Document A201™–2017, General Conditions of the Contract for Construction, SCOSE Version.
- .4 Drawings

Number	Title	Date
--------	-------	------

- .5 Specifications

Section	Title	Date	Pages
---------	-------	------	-------

.6 Addenda:

Number	Date	Pages
--------	------	-------

.7 Other Exhibits:

*(Check all boxes that apply and include appropriate information identifying the exhibit where required.)*

- AIA Document E203™–2013, Building Information Modeling and Digital Data Exhibit, dated as indicated below:
- AIA Document E204™–2017, Sustainable Projects Exhibit, dated as indicated below:
- The Sustainability Plan:
- Supplementary and other Conditions of the Contract:

.8 Other documents listed below:

*(List here any additional documents that are intended to form part of the Proposed Contract Documents.)*

## ARTICLE 9 Miscellaneous

### § 9.1 Nonresident Taxpayer Registration Affidavit Income Tax Withholding Important Tax Notice - Nonresidents Only

§ 9.1.1 Withholding Requirements for Payments to Nonresidents: SC Code of Laws §12-8-550 requires persons hiring or contracting with a nonresident conducting a business or performing personal services of a temporary nature within South Carolina to withhold 2% of each payment made to the nonresident. The withholding requirement does not apply to (1) payments on purchase orders for tangible personal property when the payments are not accompanied by services to be performed in South Carolina, (2) nonresidents who are not conducting business in South Carolina, (3) nonresidents for contracts that do not exceed \$10,000 in a calendar year, or (4) payments to a nonresident who (a) registers with either the S.C. Department of Revenue or the S.C. Secretary of State and (b) submits a Nonresident Taxpayer Registration Affidavit - Income Tax Withholding, Form I-312 to the person letting the contract.

§ 9.1.2 For information about other withholding requirements (e.g., employee withholding), contact the Withholding Section at the South Carolina Department of Revenue at 803-898-5383 or visit the Department's website at:

[www.sctax.org](http://www.sctax.org)

§ 9.1.3 This notice is for informational purposes only. This Owner does not administer and has no authority over tax issues. All registration questions should be directed to the License and Registration Section at 803-898-5872 or to the South Carolina Department of Revenue, Registration Unit, Columbia, S.C. 29214-0140. All withholding questions should be directed to the Withholding Section at 803-898-5383.

PLEASE SEE THE "NONRESIDENT TAXPAYER REGISTRATION AFFIDAVIT INCOME TAX WITHHOLDING" FORM (Available through SC Department of Revenue).



## § 9.2 Submitting Confidential Information

§ 9.2.1 For every document the Bidder submits in response to or with regard to this solicitation or request, the Bidder must separately mark with the word "CONFIDENTIAL" every page, or portion thereof, that the Bidder contends contains information that is exempt from public disclosure because it is either (a) a trade secret as defined in Section 30-4-40(a)(1), or (b) privileged & confidential, as that phrase is used in SC Code of Laws §11-35-410.

§ 9.2.2 For every document the Bidder submits in response to or with regard to this solicitation or request, the Bidder must separately mark with the words "TRADE SECRET" every page, or portion thereof, that the Bidder contends contains a trade secret as that term is defined by SC Code of Laws §39-8-20.

§ 9.2.3 For every document the Bidder submits in response to or with regard to this solicitation or request, the Bidder must separately mark with the word "PROTECTED" every page, or portion thereof, that the Bidder contends is protected by SC Code of Laws §11-35-1810.

§ 9.2.4 All markings must be conspicuous; use color, bold, underlining, or some other method in order to conspicuously distinguish the mark from the other text. Do not mark your entire Bid as confidential, trade secret, or protected! If your Bid, or any part thereof, is improperly marked as confidential or trade secret or protected, the State may, in its sole discretion, determine it nonresponsive. If only portions of a page are subject to some protection, do not mark the entire page.

§ 9.2.5 By submitting a response to this solicitation, Bidder (1) agrees to the public disclosure of every page of every document regarding this solicitation or request that was submitted at any time prior to entering into a contract (including, but not limited to, documents contained in a response, documents submitted to clarify a response, & documents submitted during negotiations), unless the page is conspicuously marked "TRADE SECRET" or "CONFIDENTIAL" or "PROTECTED", (2) agrees that any information not marked, as required by these bidding instructions, as a "Trade Secret" is not a trade secret as defined by the Trade Secrets Act, & (3) agrees that, notwithstanding any claims or markings otherwise, any prices, commissions, discounts, or other financial figures used to determine the award, as well as the final contract amount, are subject to public disclosure.

§ 9.2.6 In determining whether to release documents, the State will detrimentally rely on the Bidders' marking of documents, as required by these bidding instructions, as being either "Confidential" or "Trade Secret" or "PROTECTED".

§ 9.2.7 By submitting a response, the Bidder agrees to defend, indemnify & hold harmless the State of South Carolina, its officers & employees, from every claim, demand, loss, expense, cost, damage or injury, including attorney's fees, arising out of or resulting from the State withholding information that Bidder marked as "confidential" or "trade secret" or "PROTECTED".

## § 9.3 Solicitation Information From Sources Other Than Official Source

South Carolina Business Opportunities (SCBO) is the official state government publication for State of South Carolina solicitations. Any information on State agency solicitations obtained from any other source is unofficial and any reliance placed on such information is at the Bidder's sole risk and is without recourse under the South Carolina Consolidated Procurement Code.

## § 9.4 Builder's Risk Insurance

Bidders are directed to Exhibit A of the AIA Document A101, 2017 SCOSE Version, which, unless provided otherwise in the Bid Documents, requires the contractor to provide builder's risk insurance on the project.

## § 9.5 Tax Credit For Subcontracting With Minority Firms

§ 9.5.1 Pursuant to S.C. Code Ann. §12-6-3350, taxpayers, who utilize certified minority subcontractors, may take a tax credit equal to 4% of the payments they make to said subcontractors. The payments claimed must be based on work performed directly for a South Carolina state contract. The credit is limited to a maximum of fifty thousand dollars annually. The taxpayer is eligible to claim the credit for 10 consecutive taxable years beginning with the taxable year in which the first payment is made to the subcontractor that qualifies for the credit. After the above ten consecutive taxable years, the taxpayer is no longer eligible for the credit. The credit may be claimed on Form TC-2, "Minority Business Credit." A copy of the subcontractor's certificate from the Governor's Office of Small and Minority Business (OSMBA) is to be attached to the contractor's income tax return.

§ 9.5.2 Taxpayers must maintain evidence of work performed for a State contract by the minority subcontractor. Questions regarding the tax credit and how to file are to be referred to: SC Department of Revenue, Research and Review, Phone: (803) 898-5786, Fax: (803) 898-5888.

§ 9.5.3 The subcontractor must be certified as to the criteria of a "Minority Firm" by the Governor's Office of Small and Minority Business Assistance (OSMBA). Certificates are issued to subcontractors upon successful completion of the certification process. Questions regarding subcontractor certification are to be referred to: Governor's Office of Small and Minority Business Assistance, Phone: (803) 734-0657, Fax: (803) 734-2498. Reference: S.C. Code Ann. §11-35-5010 – Definition for Minority Subcontractor & S.C. Code Ann. §11-35-5230 (B) – Regulations for Negotiating with State Minority Firms.

## § 9.6 Other Special Conditions Of The Work

# SE-330 LUMP SUM BID FORM

*Bidders shall submit bids on only Bid Form SE-330.*

**BID SUBMITTED BY:** \_\_\_\_\_  
(Bidder's Name)

**BID SUBMITTED TO:** Coastal Carolina University  
(Agency's Name)

**FOR: PROJECT NAME:** Ingle Hall Flooring 2024  
**PROJECT NUMBER:** H17-N150-CB

## **OFFER**

§ 1. In response to the Invitation for Construction Services and in compliance with the Instructions to Bidders for the above-named Project, the undersigned Bidder proposes and agrees, if this Bid is accepted, to enter into a Contract with the Agency on the terms included in the Bidding Documents, and to perform all Work as specified or indicated in the Bidding Documents, for the prices and within the time frames indicated in this Bid and in accordance with the other terms and conditions of the Bidding Documents.

§ 2. Pursuant to SC Code § 11-35-3030(1), Bidder has submitted Bid Security in the amount and form required by the Bidding Documents.

§ 3. Bidder acknowledges the receipt of the following Addenda to the Bidding Documents and has incorporated the effects of said Addenda into this Bid:

*(Bidder, check all that apply. Note, there may be more boxes than actual addenda. Do not check boxes that do not apply)*

**ADDENDA:**             #1             #2             #3             #4             #5

§ 4. Bidder accepts all terms and conditions of the Invitation for Bids, including, without limitation, those dealing with the disposition of Bid Security. Bidder agrees that this Bid, including all Bid Alternates, if any, may not be revoked or withdrawn after the opening of bids, and shall remain open for acceptance for a period of **60** Days following the Bid Date, or for such longer period of time that Bidder may agree to in writing upon request of the Agency.

§ 5. Bidder herewith offers to provide all labor, materials, equipment, tools of trades and labor, accessories, appliances, warranties and guarantees, and to pay all royalties, fees, permits, licenses and applicable taxes necessary to complete the following items of construction work:

§ 6.1 **BASE BID WORK** *(as indicated in the Bidding Documents and generally described as follows):* Demo, prepare, and replace all flooring in 16 2nd and 3rd floor 4-bedroom suites including 202, 203, 220, 221, 246, 247, 264, 265, 302, 303, 320, 321, 346, 347, 364, and 365 as well as all flooring in 128 2nd and 3rd floor bedrooms (restroom flooring is not to be replaced). Also demo, prepare, and replace flooring in lobby with specified porcelain tile.

\$ \_\_\_\_\_, which sum is hereafter called the Base Bid.

*(Bidder to insert Base Bid Amount on line above)*

**SE-330  
LUMP SUM BID FORM**

**§ 7. LISTING OF PROPOSED SUBCONTRACTORS PURSUANT TO SECTION 3020(b)(i), CHAPTER 35, TITLE 11 OF THE SOUTH CAROLINA CODE OF LAWS, AS AMENDED**  
*(See Instructions on the following page BF-2A)*

Bidder shall use the below-listed Subcontractors in the performance of the Subcontractor Classification work listed:

<b>(A) SUBCONTRACTOR LICENSE CLASSIFICATION or SUBCLASSIFICATION NAME</b> <i>(Completed by Agency)</i>	<b>(B) LICENSE CLASSIFICATION or SUBCLASSIFICATION ABBREVIATION</b> <i>(Completed by Agency)</i>	<b>(C) SUBCONTRACTOR and/or PRIME CONTRACTOR</b> <i>(Required - must be completed by Bidder)</i>	<b>(D) SUBCONTRACTOR'S and/or PRIME CONTRACTOR'S SC LICENSE NUMBER</b> <i>(Requested, but not Required)</i>
<b>BASE BID</b>			
NO SUBCONTRACTOR LISTING REQUIRED			
<b>ALTERNATE #1</b>			
<b>ALTERNATE #2</b>			
<b>ALTERNATE #3</b>			

If a Bid Alternate is accepted, Subcontractors listed for the Bid Alternate shall be used for the work of both the Alternate and the Base Bid work.

## SE-330 LUMP SUM BID FORM

### § 8. LIST OF MANUFACTURERS, MATERIAL SUPPLIERS, AND SUBCONTRACTORS OTHER THAN SUBCONTRACTORS LISTED IN SECTION 7 ABOVE (*FOR INFORMATION ONLY*):

Pursuant to instructions in the Invitation for Construction Services, if any, Bidder will provide to Agency upon the Agency's request and within 24 hours of such request, a listing of manufacturers, material suppliers, and subcontractors, other than those listed in Section 7 above, that Bidder intends to use on the project. Bidder acknowledges and agrees that this list is provided for purposes of determining responsibility and not pursuant to the subcontractor listing requirements of SC Code § 11-35-3020(b)(i).

### § 9. TIME OF CONTRACT PERFORMANCE AND LIQUIDATED DAMAGES

#### a) CONTRACT TIME

Bidder agrees that the Date of Commencement of the Work shall be established in a Notice to Proceed to be issued by the Agency. Bidder agrees to substantially complete the Work within 34 Calendar Days from the Date of Commencement, subject to adjustments as provided in the Contract Documents.

#### b) LIQUIDATED DAMAGES

Bidder further agrees that from the compensation to be paid, the Agency shall retain as Liquidated Damages the amount of \$ 100.00 for each Calendar Day the actual construction time required to achieve Substantial Completion exceeds the specified or adjusted time for Substantial Completion as provided in the Contract Documents. This amount is intended by the parties as the predetermined measure of compensation for actual damages, not as a penalty for nonperformance.

### § 10. AGREEMENTS

- a) Bidder agrees that this bid is subject to the requirements of the laws of the State of South Carolina.
- b) Bidder agrees that at any time prior to the issuance of the Notice to Proceed for this Project, this Project may be canceled for the convenience of, and without cost to, the State.
- c) Bidder agrees that neither the State of South Carolina nor any of its agencies, employees or agents shall be responsible for any bid preparation costs, or any costs or charges of any type, should all bids be rejected or the Project canceled for any reason prior to the issuance of the Notice to Proceed.

### § 11. ELECTRONIC BID BOND

By signing below, the Principal is affirming that the identified electronic bid bond has been executed and that the Principal and Surety are firmly bound unto the State of South Carolina under the terms and conditions of the AIA Document A310, Bid Bond, referenced in the Bidding Documents.

**ELECTRONIC BID BOND NUMBER:** \_\_\_\_\_

**SIGNATURE AND TITLE:** \_\_\_\_\_

**SE-330  
LUMP SUM BID FORM**

**CONTRACTOR'S CLASSIFICATIONS AND SUBCLASSIFICATIONS WITH LIMITATION**

**SC Contractor's License Number(s):** \_\_\_\_\_

**Classification(s) & Limits:** \_\_\_\_\_

**Subclassification(s) & Limits:** \_\_\_\_\_

**By signing this Bid, the person signing reaffirms all representation and certification made by both the person signing and the Bidder, including without limitation, those appearing in Article 2 of the SCOSE Version of the AIA Document A701, Instructions to Bidders, is expressly incorporated by reference.**

**BIDDER'S LEGAL NAME:** \_\_\_\_\_

**ADDRESS:** \_\_\_\_\_

\_\_\_\_\_

**TELEPHONE:** \_\_\_\_\_

**EMAIL:** \_\_\_\_\_

**SIGNATURE:** \_\_\_\_\_ **DATE:** \_\_\_\_\_

**PRINT NAME:** \_\_\_\_\_

**TITLE:** \_\_\_\_\_

**South Carolina Division of Procurement  
Services, Office of State Engineer Version of  
 AIA<sup>®</sup> Document A101<sup>®</sup> – 2017**

***Standard Form of Agreement Between Owner and  
Contractor where the basis of payment is a Stipulated Sum***

This version of AIA Document A101<sup>®</sup>–2017 is modified by the South Carolina Division of Procurement Services, Office of State Engineer (“SCOSE”). Publication of this version of AIA Document A101–2017 does not imply the American Institute of Architects’ endorsement of any modification by SCOSE. A comparative version of AIA Document A101–2017 showing additions and deletions by SCOSE is available for review on the SCOSE Web site.

Cite this document as “AIA Document A101<sup>®</sup>–2017, Standard Form of Agreement Between Owner and Contractor where the basis of payment is a Stipulated Sum — SCOSE Version,” or “AIA Document A101<sup>®</sup>–2017 — SCOSE Version.”

# South Carolina Division of Procurement Services, Office of State Engineer Version of AIA® Document A101® – 2017

## *Standard Form of Agreement Between Owner and Contractor where the basis of payment is a Stipulated Sum*

**AGREEMENT** made as of the \_\_\_\_\_ day of \_\_\_\_\_  
in the year \_\_\_\_\_  
*(In words, indicate day, month and year.)*

**BETWEEN** the Owner:  
*(Name, legal status, address and other information)*

Coastal Carolina University  
P.O. Box 261954  
Conway, SC 29528-6054

The Owner is a Governmental Body of the State of South Carolina as defined in S.C. Code Ann. § 11-35-310.

and the Contractor:  
*(Name, legal status, address and other information)*

for the following Project:  
*(Name, State Project Number, location and detailed description)*

Ingle Hall Flooring 2024  
H17-N150-CB  
Ingle Hall, 160 Township Circle, Conway, SC

The Architect:  
*(Name, legal status, address and other information)*

Coastal Carolina University  
P.O. Box 261954  
Conway, SC 29528-6054

The Owner and Contractor agree as follows.

This version of AIA Document A101–2017 is modified by the South Carolina Division of Procurement Services, Office of State Engineer. Publication of this version of AIA Document A101 does not imply the American Institute of Architects' endorsement of any modification by South Carolina Division of Procurement Services, Office of State Engineer. A comparative version of AIA Document A101–2017 showing additions and deletions by the South Carolina Division of Procurement Services, Office of State Engineer is available for review on South Carolina state Web site.

This document has important legal consequences. Consultation with an attorney is encouraged with respect to its completion or modification.

Init.

**AIA Document A101® – 2017.** Copyright © 1915, 1918, 1925, 1937, 1951, 1958, 1961, 1963, 1967, 1974, 1977, 1987, 1991, 1997, 2007, and 2017 by The American Institute of Architects. All rights reserved. **South Carolina Division of Procurement Services, Office of State Engineer Version of AIA Document A101®–2017.** Copyright © 2016 and 2020 by The American Institute of Architects. All rights reserved. **The "American Institute of Architects," "AIA," the AIA Logo, "A101," and "AIA Contract Documents" are registered trademarks and may not be used without permission.** This document was created on 03/08/2024 12:21:51 under the terms of AIA Documents on Demand® Order No.2114514234, is not for resale, is licensed for one-time use only, and may only be used in accordance with the AIA Contract Documents® Documents-on-Demand - End User License Agreement. To report copyright violations, e-mail [copyright@aia.org](mailto:copyright@aia.org).



## TABLE OF ARTICLES

- 1 THE CONTRACT DOCUMENTS
- 2 THE WORK OF THIS CONTRACT
- 3 DATE OF COMMENCEMENT AND SUBSTANTIAL COMPLETION
- 4 CONTRACT SUM
- 5 PAYMENTS
- 6 DISPUTE RESOLUTION
- 7 TERMINATION OR SUSPENSION
- 8 MISCELLANEOUS PROVISIONS
- 9 ENUMERATION OF CONTRACT DOCUMENTS

## EXHIBIT A INSURANCE AND BONDS

### ARTICLE 1 THE CONTRACT DOCUMENTS

§ 1.1 The Contract Documents consist of this Agreement, Conditions of the Contract (General, Supplementary, and other Conditions), Drawings, Specifications, Addenda issued prior to execution of this Agreement, other documents listed in this Agreement, and Modifications issued after execution of this Agreement, all of which form the Contract, and are as fully a part of the Contract as if attached to this Agreement or repeated herein. The Contract represents the entire and integrated agreement between the parties hereto and supersedes prior negotiations, representations, or agreements, either written or oral. An enumeration of the Contract Documents, other than a Modification, appears in Article 9.

§ 1.2 Any reference in this document to the Agreement between the Owner and Contractor, AIA Document A101, or some abbreviated reference thereof, shall mean the AIA A101-2017 Standard Form of Agreement Between Owner and Contractor, SCOSE Version. Any reference in this document to the General Conditions of the Contract for Construction, AIA Document A201, or some abbreviated reference thereof, shall mean the AIA A201-2017 General Conditions of the Contract for Construction, SCOSE Version.

### ARTICLE 2 THE WORK OF THIS CONTRACT

The Contractor shall fully execute the Work described in the Contract Documents, except as specifically indicated in the Contract Documents to be the responsibility of others.

### ARTICLE 3 DATE OF COMMENCEMENT AND SUBSTANTIAL COMPLETION

§ 3.1 The Date of Commencement of the Work shall be the date fixed in a Notice to Proceed issued by the Owner. The Owner shall issue the Notice to Proceed to the Contractor in writing, no less than seven (7) days prior to the Date of Commencement. Unless otherwise provided elsewhere in the Contract Documents and provided the Contractor has secured all required insurance and surety bonds, the Contractor may commence work immediately after receipt of the Notice to Proceed.

§ 3.2 The Contract Time as provided in the Notice to Proceed for this project shall be measured from the Date of Commencement of the Work to Substantial Completion.

#### § 3.3 Substantial Completion

§ 3.3.1 Subject to adjustments of the Contract Time as provided in the Contract Documents, the Contractor shall achieve Substantial Completion of the entire Work within the Contract Time indicated in the Notice to Proceed.

§ 3.3.2 If the Contractor fails to achieve Substantial Completion as provided in this Section 3.3, liquidated damages, if any, shall be assessed as set forth in Section 4.5.

Init.

**ARTICLE 4 CONTRACT SUM**

§ 4.1 The Owner shall pay the Contractor the Contract Sum, including all accepted alternates indicated in the bid documents, in current funds for the Contractor’s performance of the Contract. The Contract Sum shall be

(\$ \_\_\_\_\_), subject to additions and deductions as provided in the Contract Documents.

**§ 4.2 Alternates**

§ 4.2.1 Alternates that are accepted, if any, included in the Contract Sum:

*(Insert the accepted Alternates.)*

Item	Price
------	-------

§ 4.3 Allowances, if any, included in the Contract Sum:

*(Identify each allowance.)*

Item	Price
------	-------

§ 4.4 Unit prices, if any:

*(Identify the item and state the unit price and quantity limitations, if any, to which the unit price will be applicable.)*

Item	Units and Limitations	Price per Unit (\$0.00)
------	-----------------------	-------------------------

**§ 4.5 Liquidated damages**

§ 4.5.1 Contractor agrees that from the compensation to be paid, the Owner shall retain as liquidated damages the amount indicated in Section 9(b) of the Bid Form for each calendar day the actual construction time required to achieve Substantial Completion exceeds the specified or adjusted time for Substantial Completion as provided in the Contract Documents. The liquidated damages amount is intended by the parties as the predetermined measure of compensation for actual damages, not as a penalty.

§ 4.6 Other:

*(Insert provisions for bonus or other incentives, if any, that might result in a change to the Contract Sum.)*

Init.

## ARTICLE 5 PAYMENTS

### § 5.1 Progress Payments

§ 5.1.1 Based upon Applications for Payment submitted to the Architect and Owner by the Contractor and Certificates for Payment issued by the Architect, the Owner shall make progress payments on account of the Contract Sum to the Contractor as provided below and elsewhere in the Contract Documents.

§ 5.1.2 The period covered by each Application for Payment shall be one calendar month ending on the last day of the month, or as follows:

§ 5.1.3 The Owner shall make payment of the certified amount to the Contractor not later than twenty-one (21) days after receipt of the Application for Payment.

§ 5.1.4 Each Application for Payment shall be based on the most recent schedule of values submitted by the Contractor in accordance with the Contract Documents. The schedule of values shall allocate the entire Contract Sum among the various portions of the Work. The schedule of values shall be prepared in such form, and supported by such data to substantiate its accuracy, as the Architect may require. This schedule of values shall be used as a basis for reviewing the Contractor's Applications for Payment.

§ 5.1.5 Applications for Payment shall show the percentage of completion of each portion of the Work as of the end of the period covered by the Application for Payment.

§ 5.1.6 Subject to S.C. Code Ann. § 12-8-550 (Withholding Requirements for Payments to Non-Residents), in accordance with AIA Document A201®-2017, General Conditions of the Contract for Construction, and subject to other provisions of the Contract Documents, the amount of each progress payment shall be computed as follows:

§ 5.1.6.1 The amount of each progress payment shall first include:

- .1 That portion of the Contract Sum properly allocable to completed Work;
- .2 That portion of the Contract Sum properly allocable to materials and equipment delivered and suitably stored at the site for subsequent incorporation in the completed construction, or, if approved in advance by the Owner, suitably stored off the site at a location agreed upon in writing; and
- .3 That portion of Construction Change Directives that the Architect determines, in the Architect's professional judgment, to be reasonably justified.

§ 5.1.6.2 The amount of each progress payment shall then be reduced by:

- .1 The aggregate of any amounts previously paid by the Owner;
- .2 The amount, if any, for Work that remains uncorrected and for which the Architect has previously withheld a Certificate for Payment as provided in Article 9 of AIA Document A201-2017;
- .3 Any amount for which the Contractor does not intend to pay a Subcontractor or material supplier, unless the Work has been performed by others the Contractor intends to pay;
- .4 For Work performed or defects discovered since the last payment application, any amount for which the Architect may withhold payment, or nullify a Certificate of Payment in whole or in part, as provided in Article 9 of AIA Document A201-2017; and
- .5 Retainage withheld pursuant to Section 5.1.7.

### § 5.1.7 Retainage

§ 5.1.7.1 For each progress payment made prior to Substantial Completion of the Work, the Owner may withhold three and one-half percent (3.5%), as retainage, from the payment otherwise due.

§ 5.1.7.2 When a portion, or division, of Work as listed in the Schedule of Values is 100% complete, that portion of the retained funds which is allocable to the completed division must be released to the Contractor. No later than ten (10) days after receipt of retained funds from the Owner, the Contractor shall pay to the subcontractor responsible for such completed work the full amount of retainage allocable to the subcontractor's work.

§ 5.1.7.3 Upon Substantial Completion of the Work, the Contractor may submit an Application for Payment that includes the retainage withheld from prior Applications for Payment pursuant to this Section 5.1.7.

§ 5.1.8 If final completion of the Work is materially delayed through no fault of the Contractor, the Owner shall pay the Contractor any additional amounts in accordance with Article 9 of AIA Document A201–2017.

§ 5.1.9 Except with the Owner’s prior approval, the Contractor shall not make advance payments to suppliers for materials or equipment which have not been delivered and stored at the site.

## § 5.2 Final Payment

§ 5.2.1 Final payment, constituting the entire unpaid balance of the Contract Sum, shall be made by the Owner to the Contractor when

- .1 the Contractor has fully performed the Contract except for the Contractor’s responsibility to correct Work as provided in Article 12 of AIA Document A201–2017, and to satisfy other requirements, if any, which extend beyond final payment; and
- .2 a final Certificate for Payment has been issued by the Architect.

§ 5.2.2 The Owner’s final payment to the Contractor shall be made no later than twenty-one (21) days after the issuance of the Architect’s final Certificate for Payment.

## ARTICLE 6 DISPUTE RESOLUTION

§ 6.1 Claims and disputes shall be resolved in accordance with Article 15 of AIA Document A201–2017.

## ARTICLE 7 TERMINATION OR SUSPENSION

§ 7.1 The Contract may be terminated by the Owner or the Contractor as provided in Article 14 of AIA Document A201–2017.

§ 7.2 The Work may be suspended by the Owner as provided in Article 14 of AIA Document A201–2017.

## ARTICLE 8 MISCELLANEOUS PROVISIONS

§ 8.1 Where reference is made in this Agreement to a provision of AIA Document A201–2017 or another Contract Document, the reference refers to that provision as amended or supplemented by other provisions of the Contract Documents.

§ 8.2 The Owner’s representative:

§ 8.2.1 The Owner designates the individual listed below as its Senior Representative (“Owner’s Senior Representative”), which individual has the responsibility for and, subject to Section 7.2.1 of the General Conditions, the authority to resolve disputes under Section 15.6 of the General Conditions:

**Name:**

**Title:**

**Address:**

**Telephone:**

**Email:**

§ 8.2.2 The Owner designates the individual listed below as its Owner’s Representative, which individual has the authority and responsibility set forth in Section 2.1.1 of the General Conditions:

**Name:**

**Title:**

**Address:**

**Telephone:**

**Email:**

§ 8.3 The Contractor’s representative:

§ 8.3.1 The Contractor designates the individual listed below as its Senior Representative (“Contractor’s Senior Representative”), which individual has the responsibility for and authority to resolve disputes under Section 15.6 of the General Conditions:

**Name:**

**Title:**  
**Address:**  
**Telephone:**  
**Email:**

§ 8.3.2 The Contractor designates the individual listed below as its Contractor's Representative, which individual has the authority and responsibility set forth in Section 3.1.1 of the General Conditions:

**Name:**  
**Title:**  
**Address:**  
**Telephone:**  
**Email:**

§ 8.4 Neither the Owner's nor the Contractor's representative shall be changed without ten days' prior notice to the other party.

§ 8.5 The Architect's representative:

**Name:**  
**Title:**  
**Address:**  
**Telephone:**  
**Email:**

#### § 8.6 Insurance and Bonds

§ 8.6.1 The Owner and the Contractor shall purchase and maintain insurance as set forth in AIA Document A101®–2017, Standard Form of Agreement Between Owner and Contractor where the basis of payment is a Stipulated Sum, Exhibit A, Insurance and Bonds, and elsewhere in the Contract Documents.

§ 8.6.2 The Contractor shall provide bonds as set forth in AIA Document A101®–2017 Exhibit A, and elsewhere in the Contract Documents.

§ 8.7 Notice in electronic format, pursuant to Article 1 of AIA Document A201–2017, may be given in accordance with AIA Document E203™–2013, Building Information Modeling and Digital Data Exhibit, if completed, or as otherwise set forth below:

*(If other than in accordance with AIA Document E203–2013, insert requirements for delivering notice in electronic format such as name, title, and email address of the recipient and whether and how the system will be required to generate a read receipt for the transmission.)*

#### § 8.8 Other Provisions:

§ 8.8.1 Additional requirements, if any, for the Contractor's Construction Schedule are as follows:

*(Check box if applicable to this Contract)*

The Construction Schedule shall be in a detailed precedence-style critical path management (CPM) or primavera-type format satisfactory to the Owner and the Architect that shall also (1) provide a graphic representation of all activities and events that will occur during performance of the Work; (2) identify each phase of construction and occupancy; and (3) set forth milestone dates that are critical in ensuring the timely and orderly completion of the Work in accordance with the requirements of the Contract Documents.

- .1 Upon review by the Owner and the Architect for conformance with milestone dates and Construction Time given in the Bidding Documents, with associated Substantial Completion date, the Construction Schedule shall be deemed part of the Contract Documents and attached to the Agreement as an Exhibit. If returned for non-conformance, the Construction Schedule shall be promptly revised by the Contractor in accordance with the recommendations of the Owner and the Architect and resubmitted.

- .2 The Contactor shall monitor the progress of the Work for conformance with the requirements of the Construction Schedule and shall promptly advise the Owner of any delays or potential delays. Whenever the Construction Schedule no longer reflects actual conditions and progress of the Work or the Contract Time is modified in accordance with the terms of the Contract Documents, the Contractor shall update the Construction Schedule to reflect such conditions.
- .3 In the event any progress report indicates any delays, the Contractor shall propose an affirmative plan to correct the delay, including overtime and/or additional labor, if necessary.
- .4 In no event shall any progress report constitute an adjustment in the Contract Time, any milestone date, or the Contract Sum unless any such adjustment is agreed to by the Owner and authorized pursuant to Change Order.

§ 8.8.2 The Owner’s review of the Contractor’s schedule is not conducted for the purpose of either determining its accuracy, completeness, or approving the construction means, methods, techniques, sequences or procedures. The Owner’s review shall not relieve the Contractor of any obligations.

**ARTICLE 9 ENUMERATION OF CONTRACT DOCUMENTS**

§ 9.1 This Agreement is comprised of the following documents:

- .1 AIA Document A101®–2017, SCOSE Version Standard Form of Agreement Between Owner and Contractor
- .2 AIA Document A101®–2017, Exhibit A, Insurance and Bonds
- .3 AIA Document A201®–2017, SCOSE Version General Conditions of the Contract for Construction
- .4 Form SE-390, Notice to Proceed – Construction Contract
- .5 Drawings

Number	Title	Date
--------	-------	------

- .6 Specifications

Section	Title	Date	Pages
---------	-------	------	-------

- .7 Addenda, if any:

Number	Date	Pages
--------	------	-------

Init.

Portions of Addenda relating to bidding or proposal requirements are not part of the Contract Documents unless the bidding or proposal requirements are also enumerated in this Article 9.

**.8 Other Exhibits:**  
*(Check all boxes that apply and include appropriate information identifying the exhibit where required.)*

AIA Document E204™–2017, Sustainable Projects Exhibit, dated as indicated below:  
*(Insert the date of the E204-2017 incorporated into this Agreement.)*

The Sustainability Plan:

Title	Date	Pages
-------	------	-------

Supplementary and other Conditions of the Contract:

Document	Title	Date	Pages
----------	-------	------	-------

**.9 Other documents, if any, listed below:**  
*(List here any additional documents that are intended to form part of the Contract Documents. AIA Document A201®–2017 provides that the advertisement or invitation to bid, Instructions to Bidders, sample forms, the Contractor’s bid or proposal, portions of Addenda relating to bidding or proposal requirements, and other information furnished by the Owner in anticipation of receiving bids or proposals, are not part of the Contract Documents unless enumerated in this Agreement. Any such documents should be listed here only if intended to be part of the Contract Documents.)*

- Form SE-310, Invitation for Construction Services**
- Instructions to Bidders (AIA Document A701-2018 OSE Version)**
- Form SE-330, Contractor’s Bid (Completed Bid Form)**
- Form SE-370, Notice of Intent to Award**
- Certificate of Procurement Authority issued by the State Fiscal Accountability Authority**

Init.

This Agreement entered into as of the day and year first written above.

\_\_\_\_\_  
**OWNER** *(Signature)*

\_\_\_\_\_  
**CONTRACTOR** *(Signature)*

\_\_\_\_\_  
*(Printed name and title)*

\_\_\_\_\_  
*(Printed name and title)*

Init.

/



# South Carolina Division of Procurement Services, Office of State Engineer Version of AIA Document A101<sup>®</sup> – 2017 Exhibit A

## Insurance and Bonds

This Insurance and Bonds Exhibit is part of the Agreement, between the Owner and the Contractor, dated the \_\_\_\_\_ day of \_\_\_\_\_ in the year \_\_\_\_\_  
*(In words, indicate day, month and year.)*

for the following **PROJECT**:  
*(Name, State Project Number, and location or address)*

Ingle Hall Flooring 2024  
H17-N150-CB  
Ingle Hall, 160 Township Circle, Conway, SC

**THE OWNER:**  
*(Name, legal status and address)*

Coastal Carolina University  
P.O. Box 261954  
Conway, SC 29528-6054

The Owner is a Governmental Body of the State of South Carolina as defined by Title 11, Chapter 35 of the South Carolina Code of Laws, as amended.

**THE CONTRACTOR:**  
*(Name, legal status and address)*

This version of AIA Document A101–2017 Exhibit A is modified by the South Carolina Division of Procurement, Office of State Engineer. Publication of this version of AIA Document A101 Exhibit A does not imply the American Institute of Architects' endorsement of any modification by the South Carolina Division of Procurement, Office of State Engineer.

This document has important legal consequences. Consultation with an attorney is encouraged with respect to its completion or modification.

## TABLE OF ARTICLES

- A.1 GENERAL
- A.2 OWNER'S INSURANCE
- A.3 CONTRACTOR'S INSURANCE AND BONDS
- A.4 SPECIAL TERMS AND CONDITIONS

### ARTICLE A.1 GENERAL

The Owner and Contractor shall purchase and maintain insurance, and provide bonds, as set forth in this Exhibit. As used in this Exhibit, the term General Conditions refers to AIA Document A201<sup>®</sup>–2017, General Conditions of the Contract for Construction, SCOSE Version.

Init.

**ARTICLE A.2 OWNER'S INSURANCE**

**§ A.2.1 General**

Prior to commencement of the Work, the Owner shall secure the insurance, and provide evidence of the coverage, required under this Article A.2 and, upon the Contractor's request, provide a copy of the policies required by Section A.2.3. The copy of the policy or policies provided shall contain all applicable conditions, definitions, exclusions, and endorsements.

**§ A.2.2 Liability Insurance**

The Owner shall be responsible for purchasing and maintaining the Owner's usual general liability insurance.

**§ A.2.3 Reserved**

**§ A.2.3.1 Reserved**

**§ A.2.3.1.1 Reserved**

**§ A.2.3.1.2 Reserved**

**§ A.2.3.1.3 Reserved**

**§ A.2.3.1.4 Reserved**

**§ A.2.3.2 Reserved**

**§ A.2.3.3 Reserved**

**§ A.2.4 Optional Insurance.**

The Owner shall purchase and maintain any insurance selected below.

**§ A.2.4.1 Other Insurance**

*(List below any other insurance coverage to be provided by the Owner and any applicable limits.)*

**Coverage**

**Limits**

**ARTICLE A.3 CONTRACTOR'S INSURANCE AND BONDS**

**§ A.3.1 General**

**§ A.3.1.1 Certificates of Insurance.** The Contractor shall provide certificates of insurance acceptable to the Owner evidencing compliance with the requirements in this Article A.3 at the following times: (1) prior to commencement of the Work; (2) upon renewal or replacement of each required policy of insurance; and (3) upon the Owner's written request. An additional certificate evidencing continuation of commercial liability coverage, including coverage for completed operations, shall be submitted with the final Application for Payment and thereafter upon renewal or replacement of such coverage until the expiration of the periods required by Section A.3.2.1 and Section A.3.3.1. The certificates will show the Owner as an additional insured on the Contractor's Commercial General Liability and excess or umbrella liability policy or policies. Information concerning reduction of coverage on account of revised limits or claims paid under the General Aggregate, or both, shall be furnished by the Contractor with reasonable promptness.

**§ A.3.1.2 Deductibles and Self-Insured Retentions.** The Contractor shall disclose to the Owner any deductible or self-insured retentions applicable to any insurance required to be provided by the Contractor.

**§ A.3.1.3 Additional Insured Obligations.** To the fullest extent permitted by law, the Contractor shall cause the commercial general liability coverage to include (1) the Owner, the Architect, and the Architect's consultants as additional insureds for claims caused in whole or in part by the Contractor's negligent acts or omissions during the

Init.

Contractor's operations; and (2) the Owner as an additional insured for claims caused in whole or in part by the Contractor's negligent acts or omissions for which loss occurs during completed operations. The additional insured coverage shall be primary and non-contributory to any of the Owner's general liability insurance policies and shall apply to both ongoing and completed operations, whether such operations be by the Contractor or by a Subcontractor or by anyone directly or indirectly employed by any of them, or by anyone for whose acts any of them may be liable. To the extent commercially available, the additional insured coverage shall be no less than that provided by Insurance Services Office, Inc. (ISO) forms CG 20 10 07 04, CG 20 37 07 04, and, with respect to the Architect and the Architect's consultants, CG 20 32 07 04.

**§ A.3.1.4** A failure by the Owner to either (i) demand a certificate of insurance or written endorsement required by Section A.3, or (ii) reject a certificate or endorsement on the grounds that it fails to comply with Section A.3, shall not be considered a waiver of Contractor's obligations to obtain the required insurance.

### **§ A.3.2 Contractor's Required Insurance Coverage**

**§ A.3.2.1** The Contractor shall purchase and maintain the following types and limits of insurance from an insurance company or insurance companies lawfully authorized to issue insurance in the jurisdiction where the Project is located. The Contractor shall maintain the required insurance until the expiration of the period for correction of Work as set forth in Section 12.2.2 of the General Conditions, for such other period for maintenance of completed operations coverage as specified in the Contract Documents, or unless a different duration is stated below:

*(If the Contractor is required to maintain insurance for a duration other than the expiration of the period for correction of Work, state the duration.)*

### **§ A.3.2.2 Commercial General Liability**

**§ A.3.2.2.1** Commercial General Liability insurance for the Project written on an occurrence form with policy limits of not less than \$1,000,000 each occurrence, \$1,000,000 general aggregate, \$1,000,000 aggregate for products-completed operations hazard, \$1,000,000 personal and advertising injury, \$50,000 fire damage (any one fire), and \$5,000 medical expense (any one person) providing coverage for claims including

- .1 damages because of bodily injury, sickness or disease, including occupational sickness or disease, and death of any person;
- .2 personal injury and advertising injury;
- .3 damages because of physical damage to or destruction of tangible property, including the loss of use of such property;
- .4 bodily injury or property damage arising out of completed operations; and
- .5 the Contractor's indemnity obligations under Section 3.18 of the General Conditions.

**§ A.3.2.2.2** The Contractor's Commercial General Liability policy under this Section A.3.2.2 shall not contain an exclusion or restriction of coverage for the following:

- .1 Claims by one insured against another insured, if the exclusion or restriction is based solely on the fact that the claimant is an insured, and there would otherwise be coverage for the claim.
- .2 Claims for property damage to the Contractor's Work arising out of the products-completed operations hazard where the damaged Work or the Work out of which the damage arises was performed by a Subcontractor.
- .3 Claims for bodily injury other than to employees of the insured.
- .4 Claims for indemnity under Section 3.18 of the General Conditions arising out of injury to employees of the insured.
- .5 Claims or loss excluded under a prior work endorsement or other similar exclusionary language.
- .6 Claims or loss due to physical damage under a prior injury endorsement or similar exclusionary language.
- .7 Claims related to residential, multi-family, or other habitational projects, if the Work is to be performed on such a project.
- .8 Claims related to roofing, if the Work involves roofing.
- .9 Claims related to exterior insulation finish systems (EIFS), synthetic stucco or similar exterior coatings or surfaces, if the Work involves such coatings or surfaces.
- .10 Claims related to earth subsidence or movement, where the Work involves such hazards.
- .11 Claims related to explosion, collapse and underground hazards, where the Work involves such hazards.

§ A.3.2.3 Automobile Liability covering vehicles owned, and non-owned vehicles used, by the Contractor, with policy limits of not less than \$1,000,000 per accident, for bodily injury, death of any person, and property damage arising out of the ownership, maintenance and use of those motor vehicles along with any other statutorily required automobile coverage.

§ A.3.2.4 The Contractor may achieve the required limits and coverage for Commercial General Liability, Employers Liability, and Automobile Liability through a combination of primary and excess or umbrella liability insurance, provided such primary and excess or umbrella insurance policies result in the same or greater coverage as the coverages required under Section A.3.2.2 and A.3.2.3, and in no event shall any excess or umbrella liability insurance provide narrower coverage than the primary policy. The excess policy shall not require the exhaustion of the underlying limits only through the actual payment by the underlying insurers. The umbrella policy limits shall not be less than \$3,000,000.

§ A.3.2.5 Workers' Compensation at statutory limits.

§ A.3.2.6 Employers' Liability with policy limits not less than \$100,000 each accident, \$100,000 each employee, and \$500,000 policy limit for claims, disability benefit and other similar employee benefit acts that are applicable to the Work to be performed.

§ A.3.2.7 Jones Act, and the Longshore & Harbor Workers' Compensation Act, as required, if the Work involves hazards arising from work on or near navigable waterways, including vessels and docks.

§ A.3.2.8 Insurance for maritime liability risks associated with the operation of a vessel, if the Work requires such activities, with policy limits of not less than (\$ ) per claim and (\$ ) in the aggregate.

§ A.3.2.9 Insurance for the use or operation of manned or unmanned aircraft, if the Work requires such activities, with policy limits of not less than (\$ ) per claim and (\$ ) in the aggregate.

### § A.3.3 Required Property Insurance

§ A.3.3.1 The Contractor shall purchase and maintain, from an insurance company or insurance companies lawfully authorized to issue insurance in the jurisdiction where the Project is located, property insurance written on a builder's risk "all-risks" completed value or equivalent policy form and sufficient to cover the total value of the entire Project on a replacement cost basis. The Contractor's property insurance coverage shall be no less than the amount of the initial Contract Sum, plus the value of subsequent Modifications and labor performed and materials or equipment supplied by others. The property insurance shall be maintained until Substantial Completion and thereafter as provided in Section A.3.3.1.3, unless otherwise provided in the Contract Documents or otherwise agreed in writing by the parties to this Agreement. This insurance shall include the interests of the Owner, Contractor, Subcontractors, and Sub-subcontractors in the Project as insureds.

§ A.3.3.1.1 **Causes of Loss.** The insurance required by this Section A.3.3.1 shall provide coverage for direct physical loss or damage and shall include the risks of fire (with extended coverage), explosion, theft, vandalism, malicious mischief, collapse, earthquake, flood, or windstorm. The insurance shall also provide coverage for ensuing loss or resulting damage from error, omission, or deficiency in construction methods, workmanship, or materials. (Indicate below the cause of loss and any applicable sub-limit.)

**Causes of Loss**

**Sub-Limit**

§ A.3.3.1.2 **Specific Required Coverages.** The insurance required by this Section A.3.3.1 shall provide coverage for loss or damage to falsework and other temporary structures, and to building systems from testing and startup. The insurance shall also cover debris removal, including demolition occasioned by enforcement of any applicable legal requirements, and reasonable compensation for the Architect's and Contractor's services and expenses required as a result of such insured loss, including claim preparation expenses. (Indicate below the cause of loss and any applicable sub-limit.)

Init.

**§ A.3.3.1.3** Unless the parties agree otherwise, upon Substantial Completion, the Owner shall replace the insurance policy required under Section A.3.3.1 with property insurance written for the total value of the Project.

**§ A.3.3.1.4 Deductibles and Self-Insured Retentions.** If the insurance required by this Section A.3.3 is subject to deductibles or self-insured retentions, the Contractor shall be responsible for all loss not covered because of such deductibles or retentions.

**§ A.3.3.2 Occupancy or Use Prior to Substantial Completion.** The Owner's occupancy or use of any completed or partially completed portion of the Work prior to Substantial Completion shall not commence until the insurance company or companies providing the insurance under Section A.3.3.1 have consented in writing to the continuance of coverage. The Owner and the Contractor shall take no action with respect to partial occupancy or use that would cause cancellation, lapse, or reduction of insurance, unless they agree otherwise in writing.

**§ A.3.3.3** If the Owner requests in writing that insurance for risks other than those described herein or other special causes of loss be included in the property insurance policy, the Contractor shall, if possible, include such insurance, and the cost thereof shall be charged to the Owner by appropriate Change Order.

**§ A.3.3.4** Before an exposure to loss may occur, the Contractor shall file with the Owner a copy of each policy that includes insurance coverages required by this Section A.3.3. Each policy shall contain all generally applicable conditions, definitions, exclusions and endorsements related to this Project.

#### **§ A.3.4 Contractor's Other Insurance Coverage**

**§ A.3.4.1** Insurance selected and described in this Section A.3.4 shall be purchased from an insurance company or insurance companies lawfully authorized to issue insurance in the jurisdiction where the Project is located. The Contractor shall maintain the required insurance until the expiration of the period for correction of Work as set forth in Section 12.2.2 of the General Conditions, unless a different duration is stated below:

*(If the Contractor is required to maintain any of the types of insurance selected below for a duration other than the expiration of the period for correction of Work, state the duration.)*

**§ A.3.4.2** The Contractor shall purchase and maintain the following types and limits of insurance in accordance with Section A.3.4.1.

*(Select the types of insurance the Contractor is required to purchase and maintain by placing an X in the box(es) next to the description(s) of selected insurance. Where policy limits are provided, include the policy limit in the appropriate fill point.)*

**§ A.3.4.2.1 Reserved**

**§ A.3.4.2.2** Insurance for physical damage to property while it is in storage and in transit to the construction site on an "all-risks" completed value form.

**§ A.3.4.2.3** Property insurance on an "all-risks" completed value form, covering property owned by the Contractor and used on the Project, including scaffolding and other equipment.

**§ A.3.4.2.4 Boiler and Machinery Insurance**  
The Contractor shall purchase and maintain boiler and machinery insurance as required, which shall specifically cover such insured objects during installation and until final acceptance by the Owner; this

insurance shall include interests of the Owner, Contractor, Subcontractors and Sub-subcontractors in the Work, and the Owner and Contractor shall be named insureds.

**§ A.3.5 Performance Bond and Payment Bond**

The Contractor shall provide surety bonds, from a company or companies lawfully authorized to issue surety bonds in the jurisdiction where the Project is located, as follows:

*(Specify type and penal sum of bonds.)*

Type	Penal Sum (\$0.00)
Payment Bond	
Performance Bond	

**§ A.3.5.1** Before commencing any services hereunder, the Contractor shall provide the Owner with Performance and Payment Bonds, each in an amount not less than the Contract Price set forth in Article 4 of the Agreement. The Surety shall have, at a minimum, a "Best Rating" of "A" as stated in the most current publication of "Best's Key Rating Guide, Property-Casualty". In addition, the Surety shall have a minimum "Best Financial Strength Category" of "Class V", and in no case less than five (5) times the contract amount. The Performance Bond shall be written on Form SE-355, "Performance Bond" and the Payment Bond shall be written on Form SE-357, "Labor and Material Payment Bond", and both shall be made payable to the Owner.

**§ A.3.5.2** The Performance and Labor and Material Payment Bonds shall:

- .1 be issued by a surety company licensed to do business in South Carolina;
- .2 be accompanied by a current power of attorney and certified by the attorney-in-fact who executes the bond on the behalf of the surety company; and
- .3 remain in effect for a period not less than one (1) year following the date of Substantial Completion or the time required to resolve any items of incomplete Work and the payment of any disputed amounts, whichever time period is longer.

**§ A.3.5.3** Any bonds required by this Contract shall meet the requirements of the South Carolina Code of Laws and Regulations, as amended.

**ARTICLE A.4 SPECIAL TERMS AND CONDITIONS**

Special terms and conditions that modify this Insurance and Bonds Exhibit, if any, are as follows:

**South Carolina Division of Procurement  
Services, Office of State Engineer Version of  
 AIA<sup>®</sup> Document A201<sup>®</sup> – 2017**

***General Conditions of the Contract for Construction***

This version of AIA Document A201<sup>®</sup>–2017 is modified by the South Carolina Division of Procurement Services, Office of State Engineer (“SCOSE”). Publication of this version of AIA Document A201–2017 does not imply the American Institute of Architects’ endorsement of any modification by SCOSE. A comparative version of AIA Document A201–2017 showing additions and deletions by SCOSE is available for review on the SCOSE Web site.

Cite this document as “AIA Document A201<sup>®</sup>–2017, General Conditions of the Contract for Construction—SCOSE Version,” or “AIA Document A201<sup>®</sup>–2017 — SCOSE Version.”



# South Carolina Division of Procurement Services, Office of State Engineer Version of AIA® Document A201® – 2017

## General Conditions of the Contract for Construction

### for the following PROJECT:

*(Name, State Project Number, and location or address)*

Ingle Hall Flooring 2024

H17-N150-CB

Ingle Hall, 160 Township Circle, Conway, SC

### THE OWNER:

*(Name, legal status, and address)*

Coastal Carolina University

P.O. Box 261954

Conway, SC 29528-6054

The Owner is a Governmental Body of the State of South Carolina as defined in S.C. Code Ann. § 11-35-310.

### THE ARCHITECT:

*(Name, legal status, and address)*

Coastal Carolina University

P.O. Box 261954

Conway, SC 29528-6054

This version of AIA Document A201–2017 is modified by the South Carolina Division of Procurement, Office of State Engineer. Publication of this version of AIA Document A201 does not imply the American Institute of Architects' endorsement of any modification by South Carolina Division of Procurement, Office of State Engineer. A comparative version of AIA Document A201–2017 showing additions and deletions by the South Carolina Division of Procurement, Office of State Engineer is available for review on the State of South Carolina Web site.

This document has important legal consequences. Consultation with an attorney is encouraged with respect to its completion or modification.

## TABLE OF ARTICLES

1	GENERAL PROVISIONS
2	OWNER
3	CONTRACTOR
4	ARCHITECT
5	SUBCONTRACTORS
6	CONSTRUCTION BY OWNER OR BY SEPARATE CONTRACTORS
7	CHANGES IN THE WORK
8	TIME
9	PAYMENTS AND COMPLETION

Init.

AIA Document A201®–2017. Copyright © 1911, 1915, 1918, 1925, 1937, 1951, 1958, 1961, 1963, 1966, 1970, 1976, 1987, 1997, 2007, and 2017 by The American Institute of Architects. All rights reserved. South Carolina Division of Procurement Services, Office of State Engineer Version of AIA Document A201®–2017. Copyright © 2016 and 2020 by The American Institute of Architects. All rights reserved. The "American Institute of Architects," "AIA," the AIA Logo, "A201," and "AIA Contract Documents" are registered trademarks and may not be used without permission. This document was created on 03/08/2024 12:28:04 under the terms of AIA Documents on Demand® Order No. 2114514234, is not for resale, is licensed for one-time use only, and may only be used in accordance with the AIA Contract Documents® Documents-on-Demand – End User License Agreement. To report copyright violations, e-mail [copyright@aia.org](mailto:copyright@aia.org).



- 10 PROTECTION OF PERSONS AND PROPERTY
- 11 INSURANCE AND BONDS
- 12 UNCOVERING AND CORRECTION OF WORK
- 13 MISCELLANEOUS PROVISIONS
- 14 TERMINATION OR SUSPENSION OF THE CONTRACT
- 15 CLAIMS AND DISPUTES
- 16 PROJECT SPECIFIC REQUIREMENTS AND INFORMATION

Init.

/

## INDEX

(Topics and numbers in bold are Section headings.)

### Acceptance of Nonconforming Work

9.6.6, 9.9.3, **12.3**

Acceptance of Work

9.6.6, 9.8.2, 9.9.3, 9.10.1, 9.10.3, 12.3

### Access to Work

**3.16**, 6.2.1, 12.1

Accident Prevention

10

Acts and Omissions

3.2, 3.3.2, 3.12.8, 3.18, 4.2.3, 8.3.1, 9.5.1, 10.2.5,

10.2.8, 13.3.2, 14.1, 15.1.2, 15.2

Addenda

1.1.1

Additional Costs, Claims for

3.7.4, 3.7.5, 10.3.2, 15.1.5

### Additional Inspections and Testing

9.4.2, 9.8.3, 12.2.1, **13.4**

### Additional Time, Claims for

3.2.4, 3.7.4, 3.7.5, 3.10.2, 8.3.2, **15.1.6**

### Administration of the Contract

3.1.3, **4.2**, 9.4, 9.5

Advertisement or Invitation to Bid

1.1.1

Aesthetic Effect

4.2.13

### Allowances

**3.8**

### Applications for Payment

4.2.5, 7.3.9, 9.2, **9.3**, 9.4, 9.5.1, 9.5.4, 9.6.3, 9.7, 9.10

Approvals

2.1.1, 2.3.1, 2.5, 3.1.3, 3.10.2, 3.12.8, 3.12.9,

3.12.10.1, 4.2.7, 9.3.2, 13.4.1

### Arbitration

8.3.1, 15.3.2, **15.4**

## ARCHITECT

**4**

Architect, Definition of

**4.1.1**

Architect, Extent of Authority

2.5, 3.12.7, 4.1.2, 4.2, 5.2, 6.3, 7.1.2, 7.3.4, 7.4, 9.2,

9.3.1, 9.4, 9.5, 9.6.3, 9.8, 9.10.1, 9.10.3, 12.1, 12.2.1,

13.4.1, 13.4.2, 14.2.2, 14.2.4, 15.1.4, 15.2.1

Architect, Limitations of Authority and Responsibility

2.1.1, 3.12.4, 3.12.8, 3.12.10, 4.1.2, 4.2.1, 4.2.2, 4.2.3,

4.2.6, 4.2.7, 4.2.10, 4.2.12, 4.2.13, 5.2.1, 7.4, 9.4.2,

9.5.4, 9.6.4, 15.1.4, 15.2

Architect's Additional Services and Expenses

2.5, 12.2.1, 13.4.2, 13.4.3, 14.2.4

Architect's Administration of the Contract

3.1.3, 3.7.4, 15.2, 9.4.1, 9.5

Architect's Approvals

2.5, 3.1.3, 3.5, 3.10.2, 4.2.7

Architect's Authority to Reject Work

3.5, 4.2.6, 12.1.2, 12.2.1

Architect's Copyright

1.1.7, 1.5

Architect's Decisions

3.7.4, 4.2.6, 4.2.7, 4.2.11, 4.2.12, 4.2.13, 4.2.14, 6.3,

7.3.4, 7.3.9, 8.1.3, 8.3.1, 9.2, 9.4.1, 9.5, 9.8.4, 9.9.1,

13.4.2, 15.2

Architect's Inspections

3.7.4, 4.2.2, 4.2.9, 9.4.2, 9.8.3, 9.9.2, 9.10.1, 13.4

Architect's Instructions

3.2.4, 3.3.1, 4.2.6, 4.2.7, 13.4.2

Architect's Interpretations

4.2.11, 4.2.12

Architect's Project Representative

4.2.10

Architect's Relationship with Contractor

1.1.2, 1.5, 2.3.3, 3.1.3, 3.2.2, 3.2.3, 3.2.4, 3.3.1, 3.4.2,

3.5, 3.7.4, 3.7.5, 3.9.2, 3.9.3, 3.10, 3.11, 3.12, 3.16,

3.18, 4.1.2, 4.2, 5.2, 6.2.2, 7, 8.3.1, 9.2, 9.3, 9.4, 9.5,

9.7, 9.8, 9.9, 10.2.6, 10.3, 11.3, 12, 13.3.2, 13.4, 15.2

Architect's Relationship with Subcontractors

1.1.2, 4.2.3, 4.2.4, 4.2.6, 9.6.3, 9.6.4, 11.3

Architect's Representations

9.4.2, 9.5.1, 9.10.1

Architect's Site Visits

3.7.4, 4.2.2, 4.2.9, 9.4.2, 9.5.1, 9.9.2, 9.10.1, 13.4

Asbestos

10.3.1

Attorneys' Fees

3.18.1, 9.6.8, 9.10.2, 10.3.3

Award of Separate Contracts

6.1.1, 6.1.2

### Award of Subcontracts and Other Contracts for Portions of the Work

**5.2**

### Basic Definitions

**1.1**

Bidding Requirements

1.1.1

Binding Dispute Resolution

8.3.1, 9.7, 11.5, 13.1, 15.1.2, 15.1.3, 15.2.1, 15.2.5,

15.2.6.1, 15.3.1, 15.3.2, 15.3.3, 15.4.1

Bonds, Lien

7.3.4.4, 9.6.8, 9.10.2, 9.10.3

### Bonds, Performance, and Payment

7.3.4.4, 9.6.7, 9.10.3, **11.1.2**, 11.1.3, **11.5**

### Building Information Models Use and Reliance

**1.8**

Building Permit

3.7.1

### Capitalization

**1.3**

Certificate of Substantial Completion

9.8.3, 9.8.4, 9.8.5

### Certificates for Payment

4.2.1, 4.2.5, 4.2.9, 9.3.3, **9.4**, 9.5, 9.6.1, 9.6.6, 9.7,

9.10.1, 9.10.3, 14.1.1.3, 14.2.4, 15.1.4

Certificates of Inspection, Testing or Approval

13.4.4

Init.

Certificates of Insurance  
9.10.2  
**Change Orders**  
1.1.1, 3.4.2, 3.7.4, 3.8.2.3, 3.11, 3.12.8, 4.2.8, 5.2.3,  
7.1.2, 7.1.3, **7.2**, 7.3.2, 7.3.7, 7.3.9, 7.3.10, 8.3.1,  
9.3.1.1, 9.10.3, 10.3.2, 11.2, 11.5, 12.1.2  
**Change Orders**, Definition of  
**7.2.1**  
**CHANGES IN THE WORK**  
2.2.2, 3.11, 4.2.8, 7, 7.2.1, 7.3.1, 7.4, 8.3.1, 9.3.1.1,  
11.5  
**Claims**, Definition of  
**15.1.1**  
Claims, Notice of  
1.6.2, 15.1.3  
**CLAIMS AND DISPUTES**  
3.2.4, 6.1.1, 6.3, 7.3.9, 9.3.3, 9.10.4, 10.3.3, **15**, 15.4  
Claims and Timely Assertion of Claims  
15.4.1  
**Claims for Additional Cost**  
3.2.4, 3.3.1, 3.7.4, 7.3.9, 9.5.2, 10.2.5, 10.3.2, **15.1.5**  
**Claims for Additional Time**  
3.2.4, 3.3.1, 3.7.4, 6.1.1, 8.3.2, 9.5.2, 10.3.2, **15.1.6**  
**Concealed or Unknown Conditions, Claims for**  
**3.7.4**  
Claims for Damages  
3.2.4, 3.18, 8.3.3, 9.5.1, 9.6.7, 10.2.5, 10.3.3, 11.3,  
11.3.2, 14.2.4, 15.1.7  
Claims Subject to Arbitration  
15.4.1  
**Cleaning Up**  
**3.15**, 6.3  
Commencement of the Work, Conditions Relating to  
2.2.1, 3.2.2, 3.4.1, 3.7.1, 3.10.1, 3.12.6, 5.2.1, 5.2.3,  
6.2.2, 8.1.2, 8.2.2, 8.3.1, 11.1, 11.2, **15.1.5**  
**Commencement of the Work**, Definition of  
**8.1.2**  
**Communications**  
3.9.1, **4.2.4**  
Completion, Conditions Relating to  
3.4.1, 3.11, 3.15, 4.2.2, 4.2.9, 8.2, 9.4.2, 9.8, 9.9.1,  
9.10, 12.2, 14.1.2, 15.1.2  
**COMPLETION, PAYMENTS AND**  
**9**  
Completion, Substantial  
3.10.1, 4.2.9, 8.1.1, 8.1.3, 8.2.3, 9.4.2, 9.8, 9.9.1,  
9.10.3, 12.2, 15.1.2  
Compliance with Laws  
2.3.2, 3.2.3, 3.6, 3.7, 3.12.10, 3.13, 9.6.4, 10.2.2, 13.1,  
13.3, 13.4.1, 13.4.2, 13.5, 14.1.1, 14.2.1.3, 15.2.8,  
15.4.2, 15.4.3  
Concealed or Unknown Conditions  
3.7.4, 4.2.8, 8.3.1, 10.3  
Conditions of the Contract  
1.1.1, 6.1.1, 6.1.4  
Consent, Written  
3.4.2, 3.14.2, 4.1.2, 9.8.5, 9.9.1, 9.10.2, 9.10.3, 13.2,  
15.4.4.2

**Consolidation or Joinder**  
**15.4.4**  
**CONSTRUCTION BY OWNER OR BY**  
**SEPARATE CONTRACTORS**  
1.1.4, **6**  
**Construction Change Directive**, Definition of  
**7.3.1**  
**Construction Change Directives**  
1.1.1, 3.4.2, 3.11, 3.12.8, 4.2.8, 7.1.1, 7.1.2, 7.1.3, **7.3**,  
9.3.1.1  
Construction Schedules, Contractor's  
3.10, 3.11, 3.12.1, 3.12.2, 6.1.3, 15.1.6.2  
**Contingent Assignment of Subcontracts**  
**5.4**, 14.2.2.2  
**Continuing Contract Performance**  
**15.1.4**  
**Contract**, Definition of  
**1.1.2**  
**CONTRACT, TERMINATION OR**  
**SUSPENSION OF THE**  
5.4.1.1, 5.4.2, 11.5, **14**  
Contract Administration  
3.1.3, 4, 9.4, 9.5  
Contract Award and Execution, Conditions Relating  
to  
3.7.1, 3.10, 5.2, 6.1  
Contract Documents, Copies Furnished and Use of  
1.5.2, 2.3.6, 5.3  
**Contract Documents**, Definition of  
**1.1.1**  
**Contract Sum**  
2.2.2, 2.2.4, 3.7.4, 3.7.5, 3.8, 3.10.2, 5.2.3, 7.3, 7.4,  
**9.1**, 9.2, 9.4.2, 9.5.1.4, 9.6.7, 9.7, 10.3.2, 11.5, 12.1.2,  
12.3, 14.2.4, 14.3.2, 15.1.4.2, **15.1.5**, **15.2.5**  
**Contract Sum**, Definition of  
**9.1**  
Contract Time  
1.1.4, 2.2.1, 2.2.2, 3.7.4, 3.7.5, 3.10.2, 5.2.3, 6.1.5,  
7.2.1.3, 7.3.1, 7.3.5, 7.3.6, 7, 7, 7.3.10, 7.4, 8.1.1,  
8.2.1, 8.2.3, 8.3.1, 9.5.1, 9.7, 10.3.2, 12.1.1, 12.1.2,  
14.3.2, 15.1.4.2, 15.1.6.1, 15.2.5  
**Contract Time**, Definition of  
8.1.1  
**CONTRACTOR**  
**3**  
Contractor, Definition of  
**3.1**, **6.1.2**  
**Contractor's Construction and Submittal**  
**Schedules**  
**3.10**, 3.12.1, 3.12.2, 4.2.3, 6.1.3, 15.1.6.2  
Contractor's Employees  
2.2.4, 3.3.2, 3.4.3, 3.8.1, 3.9, 3.18.2, 4.2.3, 4.2.6, 10.2,  
10.3, 11.3, 14.1, 14.2.1.1  
**Contractor's Liability Insurance**  
**11.1**  
Contractor's Relationship with Separate Contractors  
and Owner's Forces  
3.12.5, 3.14.2, 4.2.4, 6, 11.3, 12.2.4

Init.

Contractor's Relationship with Subcontractors  
1.2.2, 2.2.4, 3.3.2, 3.18.1, 3.18.2, 4.2.4, 5, 9.6.2, 9.6.7, 9.10.2, 11.2, 11.3, 11.4

Contractor's Relationship with the Architect  
1.1.2, 1.5, 2.3.3, 3.1.3, 3.2.2, 3.2.3, 3.2.4, 3.3.1, 3.4.2, 3.5.1, 3.7.4, 3.10, 3.11, 3.12, 3.16, 3.18, 4.2, 5.2, 6.2.2, 7, 8.3.1, 9.2, 9.3, 9.4, 9.5, 9.7, 9.8, 9.9, 10.2.6, 10.3, 11.3, 12, 13.4, 15.1.3, 15.2.1

Contractor's Representations  
3.2.1, 3.2.2, 3.5, 3.12.6, 6.2.2, 8.2.1, 9.3.3, 9.8.2

Contractor's Responsibility for Those Performing the Work  
3.3.2, 3.18, 5.3, 6.1.3, 6.2, 9.5.1, 10.2.8

Contractor's Review of Contract Documents  
3.2

Contractor's Right to Stop the Work  
2.2.2, 9.7

Contractor's Right to Terminate the Contract  
14.1

Contractor's Submittals  
3.10, 3.11, 3.12, 4.2.7, 5.2.1, 5.2.3, 9.2, 9.3, 9.8.2, 9.8.3, 9.9.1, 9.10.2, 9.10.3

Contractor's Superintendent  
3.9, 10.2.6

Contractor's Supervision and Construction Procedures  
1.2.2, 3.3, 3.4, 3.12.10, 4.2.2, 4.2.7, 6.1.3, 6.2.4, 7.1.3, 7.3.4, 7.3.6, 8.2, 10, 12, 14, 15.1.4

Coordination and Correlation  
1.2, 3.2.1, 3.3.1, 3.10, 3.12.6, 6.1.3, 6.2.1

Copies Furnished of Drawings and Specifications  
1.5, 2.3.6, 3.11

Copyrights  
1.5, **3.17**

Correction of Work  
2.5, 3.7.3, 9.4.2, 9.8.2, 9.8.3, 9.9.1, 12.1.2, **12.2**, 12.3, 15.1.3.1, 15.1.3.2, 15.2.1

**Correlation and Intent of the Contract Documents**  
**1.2**

**Cost**, Definition of  
**7.3.4**

Costs  
2.5, 3.2.4, 3.7.3, 3.8.2, 3.15.2, 5.4.2, 6.1.1, 6.2.3, 7.3.3.3, 7.3.4, 7.3.8, 7.3.9, 9.10.2, 10.3.2, 10.3.6, 11.2, 12.1.2, 12.2.1, 12.2.4, 13.4, 14

**Cutting and Patching**  
**3.14**, 6.2.5

Damage to Construction of Owner or Separate Contractors  
3.14.2, 6.2.4, 10.2.1.2, 10.2.5, 10.4, 12.2.4

Damage to the Work  
3.14.2, 9.9.1, 10.2.1.2, 10.2.5, 10.4, 12.2.4

Damages, Claims for  
3.2.4, 3.18, 6.1.1, 8.3.3, 9.5.1, 9.6.7, 10.3.3, 11.3.2, 11.3, 14.2.4, 15.1.7

Damages for Delay  
6.2.3, 8.3.3, 9.5.1.6, 9.7, 10.3.2, 14.3.2

**Date of Commencement of the Work**, Definition of  
**8.1.2**

**Date of Substantial Completion**, Definition of  
**8.1.3**

**Day**, Definition of  
**8.1.4**

Decisions of the Architect  
3.7.4, 4.2.6, 4.2.7, 4.2.11, 4.2.12, 4.2.13, 6.3, 7.3.4, 7.3.9, 8.1.3, 8.3.1, 9.2, 9.4, 9.5.1, 9.8.4, 9.9.1, 13.4.2, 14.2.2, 14.2.4, 15.1, 15.2

**Decisions to Withhold Certification**  
9.4.1, **9.5**, 9.7, 14.1.1.3

Defective or Nonconforming Work, Acceptance, Rejection and Correction of  
2.5, 3.5, 4.2.6, 6.2.3, 9.5.1, 9.5.3, 9.6.6, 9.8.2, 9.9.3, 9.10.4, 12.2.1

Definitions  
1.1, 2.1.1, 3.1.1, 3.5, 3.12.1, 3.12.2, 3.12.3, 4.1.1, 5.1, 6.1.2, 7.2.1, 7.3.1, 8.1, 9.1, 9.8.1, 15.1.1

**Delays and Extensions of Time**  
**3.2**, **3.7.4**, 5.2.3, 7.2.1, 7.3.1, **7.4**, **8.3**, 9.5.1, **9.7**, 10.3.2, **10.4**, 14.3.2, **15.1.6**, 15.2.5

**Digital Data Use and Transmission**  
**1.7**

Disputes  
6.3, 7.3.9, 15.1, 15.2

**Documents and Samples at the Site**  
**3.11**

**Drawings**, Definition of  
**1.1.5**

Drawings and Specifications, Use and Ownership of  
3.11

Effective Date of Insurance  
8.2.2

**Emergencies**  
**10.4**, 14.1.1.2, **15.1.5**

Employees, Contractor's  
3.3.2, 3.4.3, 3.8.1, 3.9, 3.18.2, 4.2.3, 4.2.6, 10.2, 10.3.3, 11.3, 14.1, 14.2.1.1

Equipment, Labor, or Materials  
1.1.3, 1.1.6, 3.4, 3.5, 3.8.2, 3.8.3, 3.12, 3.13, 3.15.1, 4.2.6, 4.2.7, 5.2.1, 6.2.1, 7.3.4, 9.3.2, 9.3.3, 9.5.1.3, 9.10.2, 10.2.1, 10.2.4, 14.2.1.1, 14.2.1.2

Execution and Progress of the Work  
1.1.3, 1.2.1, 1.2.2, 2.3.4, 2.3.6, 3.1, 3.3.1, 3.4.1, 3.7.1, 3.10.1, 3.12, 3.14, 4.2, 6.2.2, 7.1.3, 7.3.6, 8.2, 9.5.1, 9.9.1, 10.2, 10.3, 12.1, 12.2, 14.2, 14.3.1, 15.1.4

Extensions of Time  
3.2.4, 3.7.4, 5.2.3, 7.2.1, 7.3, 7.4, 9.5.1, 9.7, 10.3.2, 10.4, 14.3, 15.1.6, **15.2.5**

**Failure of Payment**  
9.5.1.3, **9.7**, 9.10.2, 13.5, 14.1.1.3, 14.2.1.2

Faulty Work  
(See Defective or Nonconforming Work)

**Final Completion and Final Payment**  
4.2.1, 4.2.9, 9.8.2, **9.10**, 12.3, 14.2.4, 14.4.3

Financial Arrangements, Owner's  
2.2.1, 13.2.2, 14.1.1.4

## GENERAL PROVISIONS

### 1

#### Governing Law

##### 13.1

Guarantees (See Warranty)

#### Hazardous Materials and Substances

##### 10.2.4, 10.3

Identification of Subcontractors and Suppliers

##### 5.2.1

#### Indemnification

3.17, 3.18, 9.6.8, 9.10.2, 10.3.3, 11.3

#### Information and Services Required of the Owner

2.1.2, 2.2, 2.3, 3.2.2, 3.12.10.1, 6.1.3, 6.1.4, 6.2.5,

9.6.1, 9.9.2, 9.10.3, 10.3.3, 11.2, 13.4.1, 13.4.2,

14.1.1.4, 14.1.4, 15.1.4

#### Initial Decision

##### 15.2

#### Initial Decision Maker, Definition of

1.1.8

Initial Decision Maker, Decisions

14.2.4, 15.1.4.2, 15.2.1, 15.2.2, 15.2.3, 15.2.4, 15.2.5

Initial Decision Maker, Extent of Authority

14.2.4, 15.1.4.2, 15.2.1, 15.2.2, 15.2.3, 15.2.4, 15.2.5

#### Injury or Damage to Person or Property

##### 10.2.8, 10.4

Inspections

3.1.3, 3.3.3, 3.7.1, 4.2.2, 4.2.6, 4.2.9, 9.4.2, 9.8.3,

9.9.2, 9.10.1, 12.2.1, 13.4

Instructions to Bidders

1.1.1

Instructions to the Contractor

3.2.4, 3.3.1, 3.8.1, 5.2.1, 7, 8.2.2, 12, 13.4.2

#### Instruments of Service, Definition of

##### 1.1.7

Insurance

6.1.1, 7.3.4, 8.2.2, 9.3.2, 9.8.4, 9.9.1, 9.10.2, 10.2.5, 11

Insurance, Notice of Cancellation or Expiration

11.1.4, 11.2.3

#### Insurance, Contractor's Liability

##### 11.1

Insurance, Effective Date of

8.2.2, 14.4.2

#### Insurance, Owner's Liability

##### 11.2

#### Insurance, Property

10.2.5, 11.2, 11.4, 11.5

Insurance, Stored Materials

9.3.2

## INSURANCE AND BONDS

### 11

Insurance Companies, Consent to Partial Occupancy

9.9.1

Insured loss, Adjustment and Settlement of

11.5

Intent of the Contract Documents

1.2.1, 4.2.7, 4.2.12, 4.2.13

#### Interest

##### 13.5

#### Interpretation

1.1.8, 1.2.3, 1.4, 4.1.1, 5.1, 6.1.2, 15.1.1

Interpretations, Written

4.2.11, 4.2.12

Judgment on Final Award

15.4.2

#### Labor and Materials, Equipment

1.1.3, 1.1.6, 3.4, 3.5, 3.8.2, 3.8.3, 3.12, 3.13, 3.15.1,

5.2.1, 6.2.1, 7.3.4, 9.3.2, 9.3.3, 9.5.1.3, 9.10.2, 10.2.1,

10.2.4, 14.2.1.1, 14.2.1.2

Labor Disputes

8.3.1

Laws and Regulations

1.5, 2.3.2, 3.2.3, 3.2.4, 3.6, 3.7, 3.12.10, 3.13, 9.6.4,

9.9.1, 10.2.2, 13.1, 13.3.1, 13.4.2, 13.5, 14, 15.2.8,

15.4

Liens

2.1.2, 9.3.1, 9.3.3, 9.6.8, 9.10.2, 9.10.4, 15.2.8

Limitations, Statutes of

12.2.5, 15.1.2, 15.4.1.1

Limitations of Liability

3.2.2, 3.5, 3.12.10, 3.12.10.1, 3.17, 3.18.1, 4.2.6,

4.2.7, 6.2.2, 9.4.2, 9.6.4, 9.6.7, 9.6.8, 10.2.5, 10.3.3,

11.3, 12.2.5, 13.3.1

Limitations of Time

2.1.2, 2.2, 2.5, 3.2.2, 3.10, 3.11, 3.12.5, 3.15.1, 4.2.7,

5.2, 5.3, 5.4.1, 6.2.4, 7.3, 7.4, 8.2, 9.2, 9.3.1, 9.3.3,

9.4.1, 9.5, 9.6, 9.7, 9.8, 9.9, 9.10, 12.2, 13.4, 14, 15,

15.1.2, 15.1.3, 15.1.5

#### Materials, Hazardous

##### 10.2.4, 10.3

Materials, Labor, Equipment and

1.1.3, 1.1.6, 3.4.1, 3.5, 3.8.2, 3.8.3, 3.12, 3.13, 3.15.1,

5.2.1, 6.2.1, 7.3.4, 9.3.2, 9.3.3, 9.5.1.3, 9.10.2,

10.2.1.2, 10.2.4, 14.2.1.1, 14.2.1.2

Means, Methods, Techniques, Sequences and

Procedures of Construction

3.3.1, 3.12.10, 4.2.2, 4.2.7, 9.4.2

Mechanic's Lien

2.1.2, 9.3.1, 9.3.3, 9.6.8, 9.10.2, 9.10.4, 15.2.8

#### Mediation

8.3.1, 15.1.3.2, 15.2.1, 15.2.5, 15.2.6, 15.3, 15.4.1,

15.4.1.1

#### Minor Changes in the Work

1.1.1, 3.4.2, 3.12.8, 4.2.8, 7.1, 7.4

## MISCELLANEOUS PROVISIONS

### 13

#### Modifications, Definition of

##### 1.1.1

Modifications to the Contract

1.1.1, 1.1.2, 2.5, 3.11, 4.1.2, 4.2.1, 5.2.3, 7, 8.3.1, 9.7,

10.3.2

#### Mutual Responsibility

##### 6.2

#### Nonconforming Work, Acceptance of

9.6.6, 9.9.3, 12.3

Init.

/

Nonconforming Work, Rejection and Correction of  
2.4, 2.5, 3.5, 4.2.6, 6.2.4, 9.5.1, 9.8.2, 9.9.3, 9.10.4,  
12.2

#### **Notice**

**1.6**, 1.6.1, 1.6.2, 2.1.2, 2.2.2., 2.2.3, 2.2.4, 2.5, 3.2.4,  
3.3.1, 3.7.4, 3.7.5, 3.9.2, 3.12.9, 3.12.10, 5.2.1, 7.4,  
8.2.2 9.6.8, 9.7, 9.10.1, 10.2.8, 10.3.2, 11.5, 12.2.2.1,  
13.4.1, 13.4.2, 14.1, 14.2.2, 14.4.2, 15.1.3, 15.1.5,  
15.1.6, 15.4.1

Notice of Cancellation or Expiration of Insurance  
11.1.4, 11.2.3

#### **Notice of Claims**

1.6.2, 2.1.2, 3.7.4, 9.6.8, 10.2.8, **15.1.3**, 15.1.5, 15.1.6,  
15.2.8, 15.3.2, 15.4.1

Notice of Testing and Inspections  
13.4.1, 13.4.2

Observations, Contractor's  
3.2, 3.7.4

Occupancy  
2.3.1, 9.6.6, 9.8

Orders, Written  
1.1.1, 2.4, 3.9.2, 7, 8.2.2, 11.5, 12.1, 12.2.2.1, 13.4.2,  
14.3.1

#### **OWNER**

##### **2**

**Owner**, Definition of  
**2.1.1**

**Owner**, Evidence of Financial Arrangements  
**2.2**, 13.2.2, 14.1.1.4

**Owner**, Information and Services Required of the  
2.1.2, **2.2**, 2.3, 3.2.2, 3.12.10, 6.1.3, 6.1.4, 6.2.5, 9.3.2,  
9.6.1, 9.6.4, 9.9.2, 9.10.3, 10.3.3, 11.2, 13.4.1, 13.4.2,  
14.1.1.4, 14.1.4, 15.1.4

Owner's Authority  
1.5, 2.1.1, 2.3.32.4, 2.5, 3.4.2, 3.8.1, 3.12.10, 3.14.2,  
4.1.2, 4.2.4, 4.2.9, 5.2.1, 5.2.4, 5.4.1, 6.1, 6.3, 7.2.1,  
7.3.1, 8.2.2, 8.3.1, 9.3.2, 9.5.1, 9.6.4, 9.9.1, 9.10.2,  
10.3.2, 11.4, 11.5, 12.2.2, 12.3, 13.2.2, 14.3, 14.4,  
15.2.7

**Owner's Insurance**  
**11.2**

Owner's Relationship with Subcontractors  
1.1.2, 5.2, 5.3, 5.4, 9.6.4, 9.10.2, 14.2.2

**Owner's Right to Carry Out the Work**  
**2.5**, 14.2.2

**Owner's Right to Clean Up**  
**6.3**

**Owner's Right to Perform Construction and to  
Award Separate Contracts**  
**6.1**

**Owner's Right to Stop the Work**  
**2.4**

Owner's Right to Suspend the Work  
14.3

Owner's Right to Terminate the Contract  
14.2, 14.4

#### **Ownership and Use of Drawings, Specifications and Other Instruments of Service**

1.1.1, 1.1.6, 1.1.7, **1.5**, 2.3.6, 3.2.2, 3.11, 3.17, 4.2.12,  
5.3

**Partial Occupancy or Use**  
9.6.6, **9.9**

**Patching, Cutting and**  
**3.14**, 6.2.5

Patents  
3.17

**Payment, Applications for**  
4.2.5, 7.3.9, 9.2, **9.3**, 9.4, 9.5, 9.6.3, 9.7, 9.8.5, 9.10.1,  
14.2.3, 14.2.4, 14.4.3

**Payment, Certificates for**  
4.2.5, 4.2.9, 9.3.3, **9.4**, 9.5, 9.6.1, 9.6.6, 9.7, 9.10.1,  
9.10.3, 14.1.1.3, 14.2.4

**Payment, Failure of**  
9.5.1.3, **9.7**, 9.10.2, 13.5, 14.1.1.3, 14.2.1.2

Payment, Final  
4.2.1, 4.2.9, **9.10**, 12.3, 14.2.4, 14.4.3

**Payment Bond, Performance Bond and**  
7.3.4.4, 9.6.7, 9.10.3, **11.1.2**

**Payments, Progress**  
9.3, **9.6**, 9.8.5, 9.10.3, 14.2.3, 15.1.4

#### **PAYMENTS AND COMPLETION** **9**

Payments to Subcontractors  
5.4.2, 9.5.1.3, 9.6.2, 9.6.3, 9.6.4, 9.6.7, 14.2.1.2

PCB  
10.3.1

**Performance Bond and Payment Bond**  
7.3.4.4, 9.6.7, 9.10.3, **11.1.2**

**Permits, Fees, Notices and Compliance with Laws**  
2.3.1, **3.7**, 3.13, 7.3.4.4, 10.2.2

#### **PERSONS AND PROPERTY, PROTECTION OF** **10**

Polychlorinated Biphenyl  
10.3.1

**Product Data**, Definition of  
**3.12.2**

**Product Data and Samples, Shop Drawings**  
3.11, **3.12**, 4.2.7

**Progress and Completion**  
4.2.2, **8.2**, 9.8, 9.9.1, 14.1.4, 15.1.4

**Progress Payments**  
9.3, **9.6**, 9.8.5, 9.10.3, 14.2.3, 15.1.4

**Project**, Definition of  
**1.1.4**

Project Representatives  
4.2.10

**Property Insurance**  
10.2.5, **11.2**

**Proposal Requirements**  
1.1.1

#### **PROTECTION OF PERSONS AND PROPERTY** **10**



Regulations and Laws  
 1.5, 2.3.2, 3.2.3, 3.6, 3.7, 3.12.10, 3.13, 9.6.4, 9.9.1,  
 10.2.2, 13.1, 13.3, 13.4.1, 13.4.2, 13.5, 14, 15.2.8, 15.4

Rejection of Work  
 4.2.6, 12.2.1

Releases and Waivers of Liens  
 9.3.1, 9.10.2

Representations  
 3.2.1, 3.5, 3.12.6, 8.2.1, 9.3.3, 9.4.2, 9.5.1, 9.10.1

Representatives  
 2.1.1, 3.1.1, 3.9, 4.1.1, 4.2.10, 13.2.1

Responsibility for Those Performing the Work  
 3.3.2, 3.18, 4.2.2, 4.2.3, 5.3, 6.1.3, 6.2, 6.3, 9.5.1, 10

Retainage  
 9.3.1, 9.6.2, 9.8.5, 9.9.1, 9.10.2, 9.10.3

**Review of Contract Documents and Field  
 Conditions by Contractor**  
**3.2**, 3.12.7, 6.1.3

Review of Contractor's Submittals by Owner and  
 Architect  
 3.10.1, 3.10.2, 3.11, 3.12, 4.2, 5.2, 6.1.3, 9.2, 9.8.2

Review of Shop Drawings, Product Data and Samples  
 by Contractor  
 3.12

**Rights and Remedies**  
 1.1.2, 2.4, 2.5, 3.5, 3.7.4, 3.15.2, 4.2.6, 5.3, 5.4, 6.1,  
 6.3, 7.3.1, 8.3, 9.5.1, 9.7, 10.2.5, 10.3, 12.2.1, 12.2.2,  
 12.2.4, **13.3**, 14, 15.4

**Royalties, Patents and Copyrights**  
**3.17**

Rules and Notices for Arbitration  
 15.4.1

**Safety of Persons and Property**  
**10.2**, 10.4

**Safety Precautions and Programs**  
 3.3.1, 4.2.2, 4.2.7, 5.3, **10.1**, 10.2, 10.4

**Samples, Definition of**  
**3.12.3**

**Samples, Shop Drawings, Product Data and**  
 3.11, **3.12**, 4.2.7

**Samples at the Site, Documents and**  
**3.11**

**Schedule of Values**  
**9.2**, 9.3.1

Schedules, Construction  
 3.10, 3.12.1, 3.12.2, 6.1.3, 15.1.6.2

Separate Contracts and Contractors  
 1.1.4, 3.12.5, 3.14.2, 4.2.4, 4.2.7, 6, 8.3.1, 12.1.2

**Separate Contractors, Definition of**  
**6.1.1**

**Shop Drawings, Definition of**  
**3.12.1**

**Shop Drawings, Product Data and Samples**  
 3.11, **3.12**, 4.2.7

**Site, Use of**  
**3.13**, 6.1.1, 6.2.1

Site Inspections  
 3.2.2, 3.3.3, 3.7.1, 3.7.4, 4.2, 9.9.2, 9.4.2, 9.10.1, 13.4

Site Visits, Architect's  
 3.7.4, 4.2.2, 4.2.9, 9.4.2, 9.5.1, 9.9.2, 9.10.1, 13.4

Special Inspections and Testing  
 4.2.6, 12.2.1, 13.4

**Specifications, Definition of**  
**1.1.6**

**Specifications**  
 1.1.1, **1.1.6**, 1.2.2, 1.5, 3.12.10, 3.17, 4.2.14

Statute of Limitations  
 15.1.2, 15.4.1.1

Stopping the Work  
 2.2.2, 2.4, 9.7, 10.3, 14.1

Stored Materials  
 6.2.1, 9.3.2, 10.2.1.2, 10.2.4

**Subcontractor, Definition of**  
**5.1.1**

**SUBCONTRACTORS**  
**5**

Subcontractors, Work by  
 1.2.2, 3.3.2, 3.12.1, 3.18, 4.2.3, 5.2.3, 5.3, 5.4, 9.3.1.2,  
 9.6.7

**Subcontractual Relations**  
**5.3**, 5.4, 9.3.1.2, 9.6, 9.10, 10.2.1, 14.1, 14.2.1

Submittals  
 3.10, 3.11, 3.12, 4.2.7, 5.2.1, 5.2.3, 7.3.4, 9.2, 9.3, 9.8,  
 9.9.1, 9.10.2, 9.10.3

Submittal Schedule  
 3.10.2, 3.12.5, 4.2.7

**Subrogation, Waivers of**  
 6.1.1, **11.3**

**Substances, Hazardous**  
**10.3**

**Substantial Completion**  
 4.2.9, 8.1.1, 8.1.3, 8.2.3, 9.4.2, **9.8**, 9.9.1, 9.10.3, 12.2,  
 15.1.2

**Substantial Completion, Definition of**  
**9.8.1**

Substitution of Subcontractors  
 5.2.3, 5.2.4

Substitution of Architect  
 2.3.3

Substitutions of Materials  
 3.4.2, 3.5, 7.3.8

**Sub-subcontractor, Definition of**  
**5.1.2**

Subsurface Conditions  
 3.7.4

**Successors and Assigns**  
**13.2**

**Superintendent**  
**3.9**, 10.2.6

**Supervision and Construction Procedures**  
 1.2.2, **3.3**, 3.4, 3.12.10, 4.2.2, 4.2.7, 6.1.3, 6.2.4, 7.1.3,  
 7.3.4, 8.2, 8.3.1, 9.4.2, 10, 12, 14, 15.1.4

Suppliers  
 1.5, 3.12.1, 4.2.4, 4.2.6, 5.2.1, 9.3, 9.4.2, 9.5.4, 9.6,  
 9.10.5, 14.2.1

Surety  
 5.4.1.2, 9.6.8, 9.8.5, 9.10.2, 9.10.3, 11.1.2, 14.2.2, 15.2.7  
 Surety, Consent of  
 9.8.5, 9.10.2, 9.10.3  
 Surveys  
 1.1.7, 2.3.4  
**Suspension by the Owner for Convenience**  
**14.3**  
 Suspension of the Work  
 3.7.5, 5.4.2, 14.3  
 Suspension or Termination of the Contract  
 5.4.1.1, 14  
**Taxes**  
 3.6, 3.8.2.1, 7.3.4.4  
**Termination by the Contractor**  
**14.1, 15.1.7**  
**Termination by the Owner for Cause**  
 5.4.1.1, **14.2**, 15.1.7  
**Termination by the Owner for Convenience**  
**14.4**  
 Termination of the Architect  
 2.3.3  
 Termination of the Contractor Employment  
 14.2.2

**TERMINATION OR SUSPENSION OF THE CONTRACT**  
**14**  
**Tests and Inspections**  
 3.1.3, 3.3.3, 3.7.1, 4.2.2, 4.2.6, 4.2.9, 9.4.2, 9.8.3, 9.9.2, 9.10.1, 10.3.2, 12.2.1, **13.4**  
**TIME**  
**8**  
**Time, Delays and Extensions of**  
 3.2.4, 3.7.4, 5.2.3, 7.2.1, 7.3.1, 7.4, **8.3**, 9.5.1, 9.7, 10.3.2, 10.4, 14.3.2, 15.1.6, 15.2.5  
 Time Limits  
 2.1.2, 2.2, 2.5, 3.2.2, 3.10, 3.11, 3.12.5, 3.15.1, 4.2, 5.2, 5.3, 5.4, 6.2.4, 7.3, 7.4, 8.2, 9.2, 9.3.1, 9.3.3, 9.4.1, 9.5, 9.6, 9.7, 9.8, 9.9, 9.10, 12.2, 13.4, 14, 15.1.2, 15.1.3, 15.4  
**Time Limits on Claims**  
 3.7.4, 10.2.8, 15.1.2, 15.1.3

Title to Work  
 9.3.2, 9.3.3  
**UNCOVERING AND CORRECTION OF WORK**  
**12**  
**Uncovering of Work**  
**12.1**  
 Unforeseen Conditions, Concealed or Unknown  
 3.7.4, 8.3.1, 10.3  
 Unit Prices  
 7.3.3.2, 9.1.2  
 Use of Documents  
 1.1.1, 1.5, 2.3.6, 3.12.6, 5.3  
**Use of Site**  
**3.13, 6.1.1, 6.2.1**  
**Values, Schedule of**  
**9.2, 9.3.1**  
 Waiver of Claims by the Architect  
 13.3.2  
 Waiver of Claims by the Contractor  
 9.10.5, 13.3.2, **15.1.7**  
 Waiver of Claims by the Owner  
 9.9.3, 9.10.3, 9.10.4, 12.2.2.1, 13.3.2, 14.2.4, **15.1.7**  
 Waiver of Consequential Damages  
 14.2.4, 15.1.7  
 Waiver of Liens  
 9.3, 9.10.2, 9.10.4  
**Waivers of Subrogation**  
 6.1.1, **11.3**  
**Warranty**  
**3.5, 4.2.9, 9.3.3, 9.8.4, 9.9.1, 9.10.2, 9.10.4, 12.2.2, 15.1.2**  
 Weather Delays  
 8.3, 15.1.6.2  
**Work, Definition of**  
**1.1.3**  
 Written Consent  
 1.5.2, 3.4.2, 3.7.4, 3.12.8, 3.14.2, 4.1.2, 9.3.2, 9.10.3, 13.2, 13.3.2, 15.4.4.2  
 Written Interpretations  
 4.2.11, 4.2.12  
 Written Orders  
 1.1.1, 2.4, 3.9, 7, 8.2.2, 12.1, 12.2, 13.4.2, 14.3.1



## ARTICLE 1 GENERAL PROVISIONS

### § 1.1 Basic Definitions

#### § 1.1.1 The Contract Documents

- .1 The Contract Documents are enumerated in the Agreement between the Owner and Contractor (hereinafter the Agreement) and consist of the Agreement, Conditions of the Contract (General, Supplementary and other Conditions), Drawings, Specifications, Addenda issued prior to execution of the Contract, other documents listed in the Agreement, and Modifications issued after execution of the Contract.
- .2 A Modification is (1) a written amendment to the Contract signed by both parties, (2) a Change Order, (3) a Construction Change Directive, or (4) a written order for a minor change in the Work issued by the Architect.
- .3 Unless specifically enumerated in the Agreement, the Contract Documents do not include the advertisement or invitation to bid, Instructions to Bidders, sample forms, other information furnished by the Owner in anticipation of receiving bids or proposals, the Contractor's bid or proposal, or portions of Addenda relating to bidding or proposal requirements.
- .4 Any reference in this document to the Agreement between the Owner and Contractor, AIA Document A101, or some abbreviated reference thereof, shall mean the AIA A101-2017, Standard Form of Agreement Between Owner and Contractor, SCOSE Version.
- .5 Any reference in this document to the General Conditions of the Contract for Construction, AIA Document A201, or some abbreviated reference thereof, shall mean the AIA A201-2017, General Conditions of the Contract for Construction, SCOSE Version.

#### § 1.1.2 The Contract

The Contract Documents form the Contract for Construction. The Contract represents the entire and integrated agreement between the parties hereto and supersedes prior negotiations, representations, or agreements, either written or oral. The Contract may be amended or modified only by a Modification. The Contract Documents shall not be construed to create a contractual relationship of any kind (1) between the Contractor and the Architect or the Architect's consultants, (2) between the Owner and a Subcontractor or a Sub-subcontractor, (3) between the Owner and the Architect or the Architect's consultants, or (4) between any persons or entities other than the Owner and the Contractor.

#### § 1.1.3 The Work

The term "Work" means the construction and services required by the Contract Documents, whether completed or partially completed, and includes all other labor, materials, equipment, and services provided or to be provided by the Contractor to fulfill the Contractor's obligations. The Work may constitute the whole or a part of the Project.

#### § 1.1.4 The Project

The Project is the total construction of which the Work performed under the Contract Documents may be the whole or a part and which may include construction by the Owner and by Separate Contractors.

#### § 1.1.5 The Drawings

The Drawings are the graphic and pictorial portions of the Contract Documents showing the design, location and dimensions of the Work, generally including plans, elevations, sections, details, schedules, and diagrams.

#### § 1.1.6 The Specifications

The Specifications are that portion of the Contract Documents consisting of the written requirements for materials, equipment, systems, standards and workmanship for the Work, and performance of related services.

#### § 1.1.7 Instruments of Service

Instruments of Service are representations, in any medium of expression now known or later developed, of the tangible and intangible creative work performed by the Architect and the Architect's consultants under their respective professional services agreements. Instruments of Service may include, without limitation, studies, surveys, models, sketches, drawings, specifications, and other similar materials.

#### § 1.1.8 Reserved

#### § 1.1.9 Notice to Proceed

The Notice to Proceed is a document issued by the Owner to the Contractor directing the Contractor to begin prosecution of the Work in accordance with the requirements of the Contract Documents. The Notice to Proceed shall fix the date on which the Contract Time will commence and establish the initial date of the Substantial Completion.

#### **§ 1.1.10 State Engineer**

“State Engineer” means the person holding the position as head of the State Engineer’s Office. The State Engineer’s Office is created by S.C. Code Ann. § 11-35-830, and is sometimes referred to in the Contract Documents as “Office of State Engineer” or “OSE.” The State Engineer is also the Chief Procurement Officer for Construction, sometimes referred to in the Contract Documents as “CPOC”.

#### **§ 1.2 Correlation and Intent of the Contract Documents**

**§ 1.2.1** The intent of the Contract Documents is to include all items necessary for the proper execution and completion of the Work by the Contractor. The Contract Documents are complementary, and what is required by one shall be as binding as if required by all; performance by the Contractor shall be required only to the extent consistent with the Contract Documents and reasonably inferable from them as being necessary to produce the indicated results. In the event of patent ambiguities within or between parts of the Contract Documents, the Contractor shall 1) provide the better quality or greater quantity of Work, or 2) comply with the more stringent requirement, either or both in accordance with the Architect’s interpretation.

**§ 1.2.1.1** The invalidity of any provision of the Contract Documents shall not invalidate the Contract or its remaining provisions. If it is determined that any provision of the Contract Documents violates any law, or is otherwise invalid or unenforceable, such determination shall not impair or otherwise affect the validity, legality, or enforceability of the remaining provision or parts of the provision of the Contract Documents, which shall remain in full force and effect as if the unenforceable provision or part were deleted.

**§ 1.2.2** Organization of the Specifications into divisions, sections and articles, and arrangement of Drawings shall not control the Contractor in dividing the Work among Subcontractors or in establishing the extent of Work to be performed by any trade.

**§ 1.2.3** Unless otherwise stated in the Contract Documents, words that have well-known technical or construction industry meanings are used in the Contract Documents in accordance with such recognized meanings.

#### **§ 1.3 Capitalization**

Terms capitalized in these General Conditions include those that are (1) specifically defined, (2) the titles of numbered articles, or (3) the titles of other documents published by the American Institute of Architects.

#### **§ 1.4 Interpretation**

In the interest of brevity the Contract Documents frequently omit modifying words such as “all” and “any” and articles such as “the” and “an,” but the fact that a modifier or an article is absent from one statement and appears in another is not intended to affect the interpretation of either statement.

#### **§ 1.5 Ownership and Use of Drawings, Specifications, and Other Instruments of Service**

**§ 1.5.1** The Architect and the Architect’s consultants shall be deemed the authors and owners of their respective Instruments of Service and retain all common law, statutory, and other reserved rights in their Instruments of Service, including copyrights. The Contractor, Subcontractors, Sub-subcontractors, and suppliers shall not own or claim a copyright in the Instruments of Service. Submittal or distribution to meet official regulatory requirements or for other purposes in connection with the Project is not to be construed as a violation of the Architect’s or Architect’s consultants’ reserved rights.

**§ 1.5.2** The Contractor, Subcontractors, Sub-subcontractors, and suppliers are authorized to use and reproduce the Instruments of Service provided to them, subject to any protocols established pursuant to Sections 1.7 and 1.8, solely and exclusively for execution of the Work. All copies made under this authorization shall bear the copyright notice, if any, shown on the Instruments of Service. The Contractor, Subcontractors, Sub-subcontractors, and suppliers may not use the Instruments of Service on other projects or for additions to the Project outside the scope of the Work without the specific written consent of the Owner, Architect, and the Architect’s consultants.

#### **§ 1.6 Notice**

**§ 1.6.1** Except as otherwise provided in Section 1.6.2, where the Contract Documents require one party to notify or give notice to the other party, such notice shall be provided in writing to the designated representative of the party to

Init.

whom the notice is addressed and shall be deemed to have been duly served if delivered in person, by mail, by courier, or by electronic transmission if a method for electronic transmission is set forth in the Agreement.

§ 1.6.2 Notice of Claims as provided in Section 15.1.3 shall be provided in writing and shall be deemed to have been duly served only if delivered to the designated representative of the party to whom the notice is addressed by certified or registered mail, or by courier providing proof of delivery.

§ 1.6.3 Notice to Contractor shall be to the address provided in Section 8.3.2 of the Agreement. Notice to Owner shall be to the address provided in Section 8.2.2 of the Agreement. Either party may designate a different address for notice by giving notice in accordance with Section 1.6.1.

### § 1.7 Digital Data Use and Transmission

The parties shall agree upon protocols governing the transmission and use of Instruments of Service or any other information or documentation, including in digital form. The parties will use AIA Document E203™–2013, Building Information Modeling and Digital Data Exhibit, to establish the protocols for the development, use, transmission, and exchange of digital data.

### § 1.8 Building Information Models Use and Reliance

Any use of, or reliance on, all or a portion of a building information model without agreement to protocols governing the use of, and reliance on, the information contained in the model and without having those protocols set forth in AIA Document E203™–2013, Building Information Modeling and Digital Data Exhibit, and the requisite AIA Document G202™–2013, Project Building Information Modeling Protocol Form, shall be at the using or relying party's sole risk and without liability to the other party and its contractors or consultants, the authors of, or contributors to, the building information model, and each of their agents and employees.

## ARTICLE 2 OWNER

### § 2.1 General

§ 2.1.1 The Owner is the person or entity identified as such in the Agreement and is referred to throughout the Contract Documents as if singular in number. The Owner shall designate in writing a representative who shall have express authority to bind the Owner with respect to all matters requiring the Owner's approval or authorization, except as provided in Section 7.1.7. Except as otherwise provided in Section 4.2.1, the Architect does not have such authority. The term "Owner" means the Owner or the Owner's Representative noted in the Agreement.

§ 2.1.2 The Owner shall furnish to the Contractor, within fifteen (15) days after receipt of a written request, information necessary and relevant for the Contractor to post Notice of Project Commencement pursuant to S.C. Code Ann. § 29-5-23.

### § 2.2 Reserved

### § 2.3 Information and Services Required of the Owner

§ 2.3.1 Except for permits and fees that are the responsibility of the Contractor under the Contract Documents, including those required under Section 3.7.1, the Owner shall secure and pay for necessary approvals, easements, assessments and charges required for construction, use or occupancy of permanent structures or for permanent changes in existing facilities.

§ 2.3.2 The Owner shall retain a design professional lawfully licensed to practice, or an entity lawfully practicing, in the jurisdiction where the Project is located. The person or entity is identified as the Architect in the Agreement and is referred to throughout the Contract Documents as if singular in number.

§ 2.3.3 If the employment of the Architect terminates, the Owner shall employ a successor to whom the Contractor has no reasonable objection and whose status under the Contract Documents shall be that of the Architect.

§ 2.3.4 The Owner shall furnish surveys describing physical characteristics, legal limitations and utility locations for the site of the Project, and a legal description of the site. Subject to the Contractor's obligations, including those in Section 3.2, the Contractor shall be entitled to rely on the accuracy of information furnished by the Owner pursuant to this Section but shall exercise proper precautions relating to the safe performance of the Work.

§ 2.3.5 The Owner shall furnish information or services required of the Owner by the Contract Documents with reasonable promptness. The Owner shall also furnish any other information or services under the Owner's control and relevant to the Contractor's performance of the Work with reasonable promptness after receiving the Contractor's written request for such information or services. However, the Owner does not warrant the accuracy of any such information requested by the Contractor that is not otherwise required of the Owner by the Contract Documents. Neither the Owner nor the Architect shall be required to conduct investigations or to furnish the Contractor with any information concerning subsurface characteristics or other conditions of the area where the Work is to be performed beyond that which is provided in the Contract Documents.

§ 2.3.6 The Owner shall furnish the Contract Documents to the Contractor in digital format.

#### § 2.4 Owner's Right to Stop the Work

If the Contractor fails to correct Work that is not in accordance with the requirements of the Contract Documents as required by Section 12.2 or repeatedly fails to carry out Work in accordance with the Contract Documents, the Owner may issue a written order to the Contractor to stop the Work, or any portion thereof, until the cause for such order has been eliminated; however, the right of the Owner to stop the Work shall not give rise to a duty on the part of the Owner to exercise this right for the benefit of the Contractor or any other person or entity, except to the extent required by Section 6.1.3.

#### § 2.5 Owner's Right to Carry Out the Work

If the Contractor defaults or neglects to carry out the Work in accordance with the Contract Documents and fails within a ten-day period after receipt of notice from the Owner to commence and continue correction of such default or neglect, including but not limited to providing necessary resources, with diligence and promptness, the Owner may, without prejudice to other remedies the Owner may have, correct such default or neglect. Such action by the Owner and amounts charged to the Contractor are both subject to prior approval of the Architect and the Architect may, pursuant to Section 9.5.1, withhold or nullify a Certificate for Payment in whole or in part, to the extent reasonably necessary to reimburse the Owner for the reasonable cost of correcting such deficiencies, including Owner's expenses and compensation for the Architect's additional services made necessary by such default, neglect, or failure. If current and future payments are not sufficient to cover such amounts, the Contractor shall pay the difference to the Owner. If the Contractor disagrees with the actions of the Owner, or the amounts claimed as costs to the Owner, the Contractor may file a Claim pursuant to Article 15.

### ARTICLE 3 CONTRACTOR

#### § 3.1 General

§ 3.1.1 The Contractor is the person or entity identified as such in the Agreement and is referred to throughout the Contract Documents as if singular in number. The Contractor shall be lawfully licensed, if required in the jurisdiction where the Project is located. The Contractor shall designate in writing a representative who shall have express authority to bind the Contractor with respect to all matters under this Contract. The term "Contractor" means the Contractor or the Contractor's Representative noted in the Agreement.

§ 3.1.2 The Contractor shall perform the Work in accordance with the Contract Documents.

§ 3.1.3 The Contractor shall not be relieved of its obligations to perform the Work in accordance with the Contract Documents either by activities or duties of the Architect in the Architect's administration of the Contract, or by tests, inspections or approvals required or performed by persons or entities other than the Contractor.

#### § 3.2 Review of Contract Documents and Field Conditions by Contractor

§ 3.2.1 Execution of the Contract by the Contractor is a representation that the Contractor has visited the site, become generally familiar with local conditions under which the Work is to be performed, and correlated personal observations with requirements of the Contract Documents.

- .1 The Contractor acknowledges that it has investigated and satisfied itself as to the general and local conditions which can affect the Work or its cost, including but not limited to (a) conditions bearing upon transportation, disposal, handling, and storage of materials; (b) the availability of labor, water, electric power, and roads; (c) uncertainties of weather, river stages, tides, or similar physical conditions at the site; (d) the conformation and conditions of the ground; and (e) the character of equipment and facilities needed preliminary to and during work performance.
- .2 The Contractor also acknowledges that it has satisfied itself as to the character, quality, and quantity of surface and subsurface materials or obstacles to be encountered insofar as this information is

reasonably ascertainable from an inspection of the site, including all exploratory work done by the Owner, as well as from the drawings and specifications made a part of this Contract.

- 3 Any failure of the Contractor to take the actions described and acknowledged in this Section will not relieve the Contractor from responsibility for estimating properly the difficulty and cost of successfully performing the Work, or for proceeding to successfully perform the Work without additional expense to the Owner.

§ 3.2.2 Because the Contract Documents are complementary, the Contractor shall, before starting each portion of the Work, carefully study and compare the various Contract Documents relative to that portion of the Work, as well as the information furnished by the Owner pursuant to Section 2.3.4, shall take field measurements of any existing conditions related to that portion of the Work, and shall observe any conditions at the site affecting it. These obligations are for the purpose of facilitating coordination and construction by the Contractor and are not for the purpose of discovering errors, omissions, or inconsistencies in the Contract Documents; however, the Contractor shall promptly report to the Architect any errors, inconsistencies or omissions discovered by or made known to the Contractor as a request for information in such form as the Architect may require. It is recognized that the Contractor's review is made in the Contractor's capacity as a contractor and not as a licensed design professional, unless otherwise specifically provided in the Contract Documents.

§ 3.2.3 The Contractor is not required to ascertain that the Contract Documents are in accordance with applicable laws, statutes, ordinances, codes, rules and regulations, or lawful orders of public authorities, but the Contractor shall promptly report to the Architect any nonconformity discovered by or made known to the Contractor as a request for information in such form as the Architect may require.

§ 3.2.4 If the Contractor believes that additional cost or time is involved because of clarifications or instructions the Architect issues in response to the Contractor's notices or requests for information pursuant to Sections 3.2.2 or 3.2.3, the Contractor shall submit Claims as provided in Article 15. If the Contractor fails to perform the obligations of Sections 3.2.2 or 3.2.3, the Contractor shall pay such costs and damages to the Owner, subject to Section 15.1.7, as would have been avoided if the Contractor had performed such obligations. If the Contractor performs those obligations, the Contractor shall not be liable to the Owner or Architect for damages resulting from latent errors, inconsistencies or omissions in the Contract Documents, for differences between field measurements or conditions and the Contract Documents, or for nonconformities of the Contract Documents to applicable laws, statutes, ordinances, codes, rules and regulations, and lawful orders of public authorities.

§ 3.2.5 The Owner is entitled to reimbursement from the Contractor for amounts paid to the Architect for evaluating and responding to the Contractor's requests for information that are not prepared in accordance with the Contract Documents or where the requested information is available to the Contractor from a careful study and comparison of the Contract Documents, field conditions, other Owner-provided information, Contractor-prepared coordination drawings, or prior Project correspondence or documentation.

### § 3.3 Supervision and Construction Procedures

§ 3.3.1 The Contractor shall supervise and direct the Work, using the Contractor's best skill and attention. The Contractor shall be solely responsible for, and have control over, construction means, methods, techniques, sequences, and procedures, and for coordinating all portions of the Work under the Contract. If the Contract Documents give specific instructions concerning construction means, methods, techniques, sequences, or procedures, the Contractor shall evaluate the jobsite safety thereof and shall be solely responsible for the jobsite safety of such means, methods, techniques, sequences, or procedures. If the Contractor determines that such means, methods, techniques, sequences or procedures may not be safe, the Contractor shall give timely notice to the Owner and Architect, and shall propose alternative means, methods, techniques, sequences, or procedures. The Architect shall evaluate the proposed alternative solely for conformance with the design intent for the completed construction and provide its findings to the Owner. Unless the Owner objects to the Contractor's proposed alternative, the Contractor shall perform the Work using its alternative means, methods, techniques, sequences, or procedures.

§ 3.3.2 The Contractor shall be responsible to the Owner for acts and omissions of the Contractor's employees, Subcontractors and their agents and employees, and other persons or entities performing portions of the Work for, or on behalf of, the Contractor or any of its Subcontractors.

§ 3.3.3 The Contractor shall be responsible for inspection of portions of Work already performed to determine that such portions are in proper condition to receive subsequent Work.



## § 3.4 Labor and Materials

§ 3.4.1 Unless otherwise provided in the Contract Documents, the Contractor shall provide and pay for labor, materials, equipment, tools, construction equipment and machinery, water, heat, utilities, transportation, and other facilities and services necessary for proper execution and completion of the Work, whether temporary or permanent and whether or not incorporated or to be incorporated in the Work.

§ 3.4.2 Except in the case of minor changes in the Work approved by the Architect in accordance with Section 3.12.8 or ordered by the Architect in accordance with Section 7.4, the Contractor may make substitutions only with the consent of the Owner, after evaluation by the Architect and in accordance with a Change Order or Construction Change Directive.

§ 3.4.2.1 After the Contract has been executed, the Owner and Architect may consider requests for the substitution of products in place of those specified. The Owner and Architect may, but are not obligated to, consider only those substitution requests that are in full compliance with the conditions set forth in the General Requirements (Division 1 of the Specifications). By making requests for substitutions, the Contractor:

- .1 represents that it has personally investigated the proposed substitute product and determined that it is equal or superior in all respects to the product specified;
- .2 represents that it will provide the same warranty for the substitution as it would have provided for the product specified;
- .3 certifies that the cost data presented is complete and includes all related costs for the substituted product and for Work that must be performed or changes as a result of the substitution, except for the Architect's re-design costs, and waives all claims for additional costs related to the substitution that subsequently become apparent;
- .4 agrees that it shall, if the substitution is approved, coordinate the installation of the accepted substitute, making such changes as may be required for the Work to be complete in all respects; and
- .5 represents that the request includes a written representation identifying any potential effect the substitution may have on Project's achievement of a Sustainable Measure or the Sustainable Objective.

§ 3.4.2.2 The Owner shall be entitled to reimbursement from the Contractor for amounts paid to the Architect for reviewing the Contractor's proposed substitutions and making agreed-upon changes in the Drawings and Specifications resulting from such substitutions.

§ 3.4.3 The Contractor shall enforce strict discipline and good order among the Contractor's employees and other persons carrying out the Work. The Contractor shall not permit employment of unfit persons or persons not properly skilled in tasks assigned to them.

## § 3.5 Warranty

§ 3.5.1 The Contractor warrants to the Owner and Architect that materials and equipment furnished under the Contract will be of good quality and new unless the Contract Documents require or permit otherwise. The Contractor further warrants that the Work will conform to the requirements of the Contract Documents and will be free from defects, except for those inherent in the quality of the Work the Contract Documents require or permit. Work, materials, or equipment not conforming to these requirements shall be considered defective. Unless caused by the Contractor or a subcontractor at any tier, the Contractor's warranty excludes remedy for damage or defect caused by abuse, alterations to the Work not executed by the Contractor, improper or insufficient maintenance, improper operation, or normal wear and tear and normal usage. If required by the Architect, the Contractor shall furnish satisfactory evidence as to the kind and quality of materials and equipment.

§ 3.5.2 All material, equipment, or other special warranties required by the Contract Documents shall be issued in the name of the Owner, or shall be transferable to the Owner, and shall commence in accordance with Section 9.8.4.

## § 3.6 Taxes

The Contractor shall pay sales, consumer, use and similar taxes for the Work provided by the Contractor that are legally enacted when bids are received or negotiations concluded, whether or not yet effective or merely scheduled to go into effect. The Contractor shall comply with the requirements of S.C Code Ann. Title 12, Chapter 8, regarding withholding tax for nonresidents, employees, contractors and subcontractors.

### § 3.7 Permits, Fees, Notices and Compliance with Laws

§ 3.7.1 Pursuant to S.C. Code Ann. § 10-1-180, no local general or specialty building permits are required for state buildings. Unless otherwise provided in the Contract Documents, the Contractor shall secure and pay for all other permits, fees, and licenses by government agencies necessary for proper execution and completion of the Work that are customarily secured after execution of the Contract and legally required at the time bids are received or negotiations concluded.

§ 3.7.2 The Contractor shall comply with and give notices required by applicable laws, statutes, ordinances, codes, rules and regulations, and lawful orders of public authorities applicable to performance of the Work.

§ 3.7.3 If the Contractor performs Work knowing it to be contrary to applicable laws, statutes, ordinances, codes, rules and regulations, or lawful orders of public authorities, the Contractor shall assume appropriate responsibility for such Work and shall bear the costs attributable to correction.

### § 3.7.4 Concealed or Unknown Conditions

If the Contractor encounters conditions at the site that are (1) subsurface or otherwise concealed physical conditions that differ materially from those indicated in the Contract Documents or (2) unknown physical conditions of an unusual nature that differ materially from those ordinarily found to exist and generally recognized as inherent in construction activities of the character provided for in the Contract Documents, the Contractor shall promptly provide notice to the Owner and the Architect before conditions are disturbed and in no event later than 14 days after first observance of the conditions. The Architect will promptly investigate such conditions and, if the Architect determines that they differ materially and cause an increase or decrease in the Contractor's cost of, or time required for, performance of any part of the Work, will recommend that an equitable adjustment be made in the Contract Sum or Contract Time, or both. If the Architect determines that the conditions at the site are not materially different from those indicated in the Contract Documents and that no change in the terms of the Contract is justified, the Architect shall promptly notify the Owner and Contractor, stating the reasons. If either party disputes the Architect's determination or recommendation, that party may submit a Claim as provided in Article 15.

§ 3.7.5 If, in the course of the Work, the Contractor encounters human remains or recognizes the existence of burial markers, archaeological sites or wetlands not indicated in the Contract Documents, the Contractor shall immediately suspend any operations that would affect them and shall notify the Owner and Architect. Upon receipt of such notice, the Owner shall promptly take any action necessary to obtain governmental authorization required to resume the operations. The Contractor shall continue to suspend such operations until otherwise instructed by the Owner but shall continue with all other operations that do not affect those remains or features. Requests for adjustments in the Contract Sum and Contract Time arising from the existence of such remains or features may be made as provided in Article 15.

### § 3.8 Allowances

§ 3.8.1 The Contractor shall include in the Contract Sum all allowances stated in the Contract Documents. Items covered by allowances shall be supplied for such amounts and by such persons or entities as the Owner may direct, but the Contractor shall not be required to employ persons or entities to whom the Contractor has reasonable objection.

§ 3.8.2 Unless otherwise provided in the Contract Documents,

- .1 allowances shall cover the cost to the Contractor of materials and equipment delivered at the site and all required taxes, less applicable trade discounts;
- .2 Contractor's costs for unloading and handling at the site, labor, installation costs, overhead, profit, and other expenses contemplated for stated allowance amounts shall be included in the Contract Sum but not in the allowances; and
- .3 whenever costs are more than or less than allowances, the Contract Sum shall be adjusted accordingly by Change Order. The amount of the Change Order shall reflect the difference between actual costs, as documented by invoices, and the allowances under Section 3.8.2.1.

§ 3.8.3 Materials and equipment under an allowance shall be selected by the Owner with reasonable promptness.

### § 3.9 Superintendent

§ 3.9.1 The Contractor shall employ a competent superintendent, acceptable to the Owner, and necessary assistants who shall be in attendance at the Project site during performance of the Work. The superintendent shall represent the Contractor, and communications given to the superintendent shall be as binding as if given to the Contractor.

§ 3.9.2 The Contractor, as soon as practicable after award of the Contract, shall notify the Owner and Architect of the name and qualifications of a proposed superintendent. Within 14 days of receipt of the information, the Owner may notify the Contractor, stating whether the Owner has reasonable objection to the proposed superintendent. Failure of the Owner to provide notice within the 14-day period shall constitute notice of no reasonable objection.

§ 3.9.3 The Contractor shall not employ a proposed superintendent to whom the Owner has made reasonable and timely objection. The Contractor shall notify the Owner of any proposed change in the superintendent, including the reason therefore, prior to making such change. The Contractor shall not change the superintendent without the Owner's consent, which shall not unreasonably be withheld or delayed.

### § 3.10 Contractor's Construction and Submittal Schedules

§ 3.10.1 The Contractor, promptly after being awarded the Contract, shall submit for the Owner's and Architect's information a Contractor's construction schedule for the Work. Subject to any additional requirements in the Contract Documents, the schedule shall contain detail appropriate for the Project, including at a minimum (1) the date of commencement of the Work, interim schedule milestone dates, and the date of Substantial Completion; (2) an apportionment of the Work by construction activity; and (3) the time required for completion of each portion of the Work. The schedule shall provide for the orderly progression of the Work to completion and shall not exceed time limits current under the Contract Documents. The schedule shall be revised at appropriate intervals as required by the conditions of the Work and Project.

§ 3.10.2 The Contractor, promptly after being awarded the Contract and thereafter as necessary to maintain a current submittal schedule, shall submit a submittal schedule for the Architect's approval. The Architect's approval shall not be unreasonably delayed or withheld. The submittal schedule shall (1) be coordinated with the Contractor's construction schedule, and (2) allow the Architect reasonable time to review submittals. If the Contractor fails to submit a submittal schedule, or fails to provide submittals in accordance with the approved submittal schedule, the Contractor shall not be entitled to any increase in Contract Sum or extension of Contract Time based on the time required for review of submittals.

§ 3.10.3 The Contractor shall perform the Work in general accordance with the most recent schedules submitted to the Owner and Architect.

### § 3.11 Documents and Samples at the Site

The Contractor shall make available, at the Project site, the Contract Documents, including Change Orders, Construction Change Directives, and other Modifications, in good order and marked currently to indicate field changes and selections made during construction, and the approved Shop Drawings, Product Data, Samples, and similar required submittals. These shall be in electronic form or paper copy, available to the Architect and Owner, and delivered to the Architect for submittal to the Owner upon completion of the Work as a record of the Work as constructed.

### § 3.12 Shop Drawings, Product Data and Samples

§ 3.12.1 Shop Drawings are drawings, diagrams, schedules, and other data specially prepared for the Work by the Contractor or a Subcontractor, Sub-subcontractor, manufacturer, supplier, or distributor to illustrate some portion of the Work.

§ 3.12.2 Product Data are illustrations, standard schedules, performance charts, instructions, brochures, diagrams, and other information furnished by the Contractor to illustrate materials or equipment for some portion of the Work.

§ 3.12.3 Samples are physical examples that illustrate materials, equipment, or workmanship, and establish standards by which the Work will be judged.

§ 3.12.4 Shop Drawings, Product Data, Samples, and similar submittals are not Contract Documents. Their purpose is to demonstrate how the Contractor proposes to conform to the information given and the design concept expressed in the Contract Documents for those portions of the Work for which the Contract Documents require submittals. Review by the Architect is subject to the limitations of Section 4.2.7. Informational submittals upon which the Architect is not expected to take responsive action may be so identified in the Contract Documents. Submittals that are not required by the Contract Documents may be returned by the Architect without action.



§ 3.12.5 The Contractor shall review for compliance with the Contract Documents, approve, and submit to the Architect, Shop Drawings, Product Data, Samples, and similar submittals required by the Contract Documents, in accordance with the submittal schedule approved by the Architect or, in the absence of an approved submittal schedule, with reasonable promptness and in such sequence as to cause no delay in the Work or in the activities of the Owner or of Separate Contractors.

- .1 The fire sprinkler shop drawings shall be prepared by a licensed fire sprinkler contractor and shall accurately reflect actual conditions affecting the required layout of the fire sprinkler system. The fire sprinkler contractor shall certify the accuracy of its shop drawings prior to submitting them for review and approval.
- .2 The fire sprinkler shop drawings shall be reviewed and approved by the Architect's engineer of record (EOR) prior to submittal to the Office of State Fire Marshal (OSFM).
- .3 The EOR shall submit to OSFM in accordance with the OSFM process.
- .4 Unless authorized in writing by OSE, neither the Contractor nor subcontractor at any tier shall submit the fire sprinkler shop drawings directly to OSFM.

§ 3.12.6 By submitting Shop Drawings, Product Data, Samples, and similar submittals, the Contractor represents to the Owner and Architect that the Contractor has (1) reviewed and approved them, (2) determined and verified materials, field measurements and field construction criteria related thereto, or will do so, and (3) checked and coordinated the information contained within such submittals with the requirements of the Work and of the Contract Documents.

§ 3.12.7 The Contractor shall perform no portion of the Work for which the Contract Documents require submittal and review of Shop Drawings, Product Data, Samples, or similar submittals, until the respective submittal has been approved by the Architect.

§ 3.12.8 The Work shall be in accordance with approved submittals except that the Contractor shall not be relieved of responsibility for deviations from the requirements of the Contract Documents by the Architect's approval of Shop Drawings, Product Data, Samples, or similar submittals, unless the Contractor has specifically notified the Architect of such deviation at the time of submittal and (1) the Architect has given written approval to the specific deviation as a minor change in the Work, or (2) a Change Order or Construction Change Directive has been issued authorizing the deviation. The Contractor shall not be relieved of responsibility for errors or omissions in Shop Drawings, Product Data, Samples, or similar submittals, by the Architect's approval thereof.

§ 3.12.9 The Contractor shall direct specific attention, in writing or on resubmitted Shop Drawings, Product Data, Samples, or similar submittals, to revisions other than those requested by the Architect on previous submittals. In the absence of such notice, the Architect's approval of a resubmission shall not apply to such revisions.

§ 3.12.10 The Contractor shall not be required to provide professional services that constitute the practice of architecture or engineering unless such services are specifically required by the Contract Documents for a portion of the Work or unless the Contractor needs to provide such services in order to carry out the Contractor's responsibilities for construction means, methods, techniques, sequences, and procedures. The Contractor shall not be required to provide professional services in violation of applicable law.

§ 3.12.10.1 If professional design services or certifications by a design professional related to systems, materials, or equipment are specifically required of the Contractor by the Contract Documents, the Owner and the Architect will specify all performance and design criteria that such services must satisfy. The Contractor shall be entitled to rely upon the adequacy and accuracy of the performance and design criteria provided in the Contract Documents. The Contractor shall cause such services or certifications to be provided by an appropriately licensed design professional, who shall comply with reasonable requirements of the Owner regarding qualifications and insurance and whose signature and seal shall appear on all drawings, calculations, specifications, certifications, Shop Drawings, and other submittals prepared by such professional. Shop Drawings, and other submittals related to the Work, designed or certified by such professional, if prepared by others, shall bear such professional's written approval when submitted to

the Architect. The Owner and the Architect shall be entitled to rely upon the adequacy and accuracy of the services, certifications, and approvals performed or provided by such design professionals, provided the Owner and Architect have specified to the Contractor the performance and design criteria that such services must satisfy. Pursuant to this Section 3.12.10, the Architect will review and approve or take other appropriate action on submittals only for the limited purpose of checking for conformance with information given and the design concept expressed in the Contract Documents.

§ 3.12.10.2 The Contractor shall not be responsible for the adequacy of the performance and design criteria specified in the Contract Documents.

### § 3.13 Use of Site

§ 3.13.1 The Contractor shall confine operations at the site to areas permitted by applicable laws, statutes, ordinances, codes, rules and regulations, lawful orders of public authorities, and the Contract Documents and shall not unreasonably encumber the site with materials or equipment.

§ 3.13.2 The Contractor and any entity for which the Contractor is responsible shall not erect any sign on the Project site without the prior written consent of the Owner.

### § 3.14 Cutting and Patching

§ 3.14.1 The Contractor shall be responsible for cutting, fitting, or patching required to complete the Work or to make its parts fit together properly. All areas requiring cutting, fitting, or patching shall be restored to the condition existing prior to the cutting, fitting, or patching, unless otherwise required by the Contract Documents.

§ 3.14.2 The Contractor shall not damage or endanger a portion of the Work or fully or partially completed construction of the Owner or Separate Contractors by cutting, patching, or otherwise altering such construction, or by excavation. The Contractor shall not cut or otherwise alter construction by the Owner or a Separate Contractor except with written consent of the Owner and of the Separate Contractor. Consent shall not be unreasonably withheld. The Contractor shall not unreasonably withhold, from the Owner or a Separate Contractor, its consent to cutting or otherwise altering the Work.

### § 3.15 Cleaning Up

§ 3.15.1 The Contractor shall keep the premises and surrounding area free from accumulation of waste materials and rubbish caused by operations under the Contract. At completion of the Work, the Contractor shall remove waste materials, rubbish, the Contractor's tools, construction equipment, machinery, and surplus materials from and about the Project.

§ 3.15.2 If the Contractor fails to clean up as provided in the Contract Documents, the Owner may do so and the Owner shall be entitled to reimbursement from the Contractor.

### § 3.16 Access to Work

The Contractor shall provide the Owner and Architect with access to the Work in preparation and progress wherever located.

### § 3.17 Royalties, Patents and Copyrights

The Contractor shall pay all royalties and license fees. The Contractor shall defend suits or claims for infringement of copyrights and patent rights and shall hold the Owner and Architect harmless from loss on account thereof, but shall not be responsible for defense or loss when a particular design, process, or product of a particular manufacturer or manufacturers is required by the Contract Documents, or where the copyright violations are contained in Drawings, Specifications, or other documents prepared by the Owner or Architect. However, if an infringement of a copyright or patent is discovered by, or made known to, the Contractor, the Contractor shall be responsible for the loss unless the information is promptly furnished to the Architect.

### § 3.18 Indemnification

§ 3.18.1 To the fullest extent permitted by law, the Contractor shall indemnify and hold harmless the Owner, Architect, Architect's consultants, and agents and employees of any of them from and against claims, damages, losses, and expenses, including but not limited to attorneys' fees, arising out of or resulting from performance of the Work, provided that such claim, damage, loss, or expense is attributable to bodily injury, sickness, disease or death, or to injury to or destruction of tangible property (other than the Work itself) including loss of use resulting therefrom, but

only to the extent caused by the negligent acts or omissions of the Contractor, a Subcontractor, anyone directly or indirectly employed by them, or anyone for whose acts they may be liable, regardless of whether or not such claim, damage, loss, or expense is caused in part by a party indemnified hereunder. Such obligation shall not be construed to negate, abridge, or reduce other rights or obligations of indemnity that would otherwise exist as to a party or person described in this Section 3.18.

§ 3.18.2 In claims against any person or entity indemnified under this Section 3.18 by an employee of the Contractor, a Subcontractor, anyone directly or indirectly employed by them, or anyone for whose acts they may be liable, the indemnification obligation under Section 3.18.1 shall not be limited by a limitation on amount or type of damages, compensation, or benefits payable by or for the Contractor or a Subcontractor under workers' compensation acts, disability benefit acts, or other employee benefit acts.

## ARTICLE 4 ARCHITECT

### § 4.1 General

§ 4.1.1 The Architect is the person or entity retained by the Owner pursuant to Section 2.3.2 and identified as such in the Agreement.

§ 4.1.2 Duties, responsibilities, and limitations of authority of the Architect as set forth in the Contract Documents shall not be restricted, modified, or extended without written consent of the Owner, Contractor, and Architect. Consent shall not be unreasonably withheld.

### § 4.2 Administration of the Contract

§ 4.2.1 The Architect will provide administration of the Contract as described in the Contract Documents and will be an Owner's representative during construction until the date the Architect issues the final Certificate for Payment. The Architect will have authority to act on behalf of the Owner only to the extent provided in the Contract Documents. Any reference in the Contract Documents to the Architect taking action or rendering a decision with a "reasonable time" is understood to mean no more than ten (10) days, unless otherwise specified in the Contract Documents or otherwise agreed to by the parties.

§ 4.2.2 The Architect will visit the site as necessary to fulfill its obligation to the Owner for inspection services, if any, and, at a minimum, to assure conformance with the Architect's design as shown in the Contract Documents and to observe the progress and quality of the portion of the Work completed, and to determine in general if the Work observed is being performed in a manner indicating that the Work, when fully completed, will be in accordance with the Contract Documents. However, the Architect will not be required to make exhaustive or continuous on-site inspections to check the quality or quantity of the Work. The Architect will not have control over, charge of, or responsibility for the construction means, methods, techniques, sequences or procedures, or for the safety precautions and programs in connection with the Work, since these are solely the Contractor's rights and responsibilities under the Contract Documents.

§ 4.2.3 On the basis of the site visits, the Architect will keep the Owner informed about the progress and quality of the portion of the Work completed, and promptly report to the Owner (1) deviations from the Contract Documents, (2) deviations from the most recent construction schedule submitted by the Contractor, and (3) defects and deficiencies observed in the Work. The Architect will not be responsible for the Contractor's failure to perform the Work in accordance with the requirements of the Contract Documents. The Architect will not have control over or charge of, and will not be responsible for acts or omissions of, the Contractor, Subcontractors, or their agents or employees, or any other persons or entities performing portions of the Work.

### § 4.2.4 Communications

The Owner and Contractor shall include the Architect in all communications that relate to or affect the Architect's services or professional responsibilities. The Owner shall promptly notify the Architect of the substance of any direct communications between the Owner and the Contractor otherwise relating to the Project. Communications by and with the Architect's consultants shall be through the Architect. Communications by and with Subcontractors and suppliers shall be through the Contractor. Communications by and with Separate Contractors shall be through the Owner. The Contract Documents may specify other communication protocols.

§ 4.2.5 Based on the Architect's evaluations of the Work completed and correlated with the Contractor's Applications for Payment, the Architect will review and certify the amounts due the Contractor and will issue Certificates for Payment in such amounts.

§ 4.2.6 The Architect has authority to reject Work that does not conform to the Contract Documents. Whenever the Architect considers it necessary or advisable, the Architect will have authority to require inspection or testing of the Work in accordance with Sections 13.4.2 and 13.4.3, whether or not the Work is fabricated, installed or completed. However, neither this authority of the Architect nor a decision made in good faith either to exercise or not to exercise such authority shall give rise to a duty or responsibility of the Architect to the Contractor, Subcontractors, suppliers, their agents or employees, or other persons or entities performing portions of the Work.

§ 4.2.7 The Architect will review and approve, or take other appropriate action upon, the Contractor's submittals such as Shop Drawings, Product Data, and Samples, but only for the limited purpose of checking for conformance with information given and the design concept expressed in the Contract Documents. The Architect's action will be taken in accordance with the submittal schedule approved by the Architect or, in the absence of an approved submittal schedule, with reasonable promptness while allowing sufficient time in the Architect's professional judgment to permit adequate review. Review of such submittals is not conducted for the purpose of determining the accuracy and completeness of other details such as dimensions and quantities, or for substantiating instructions for installation or performance of equipment or systems, all of which remain the responsibility of the Contractor as required by the Contract Documents. The Architect's review of the Contractor's submittals shall not relieve the Contractor of the obligations under Sections 3.3, 3.5, and 3.12. The Architect's review shall not constitute approval of safety precautions or of any construction means, methods, techniques, sequences, or procedures. The Architect's approval of a specific item shall not indicate approval of an assembly of which the item is a component.

§ 4.2.8 The Architect will prepare Change Orders and Construction Change Directives, and may order minor changes in the Work as provided in Section 7.4. The Architect will investigate and make determinations and recommendations regarding concealed and unknown conditions as provided in Section 3.7.4.

§ 4.2.9 The Architect will conduct inspections to determine the date or dates of Substantial Completion and the date of final completion; issue Certificates of Substantial Completion pursuant to Section 9.8; receive and forward to the Owner, for the Owner's review and records, written warranties and related documents required by the Contract and assembled by the Contractor pursuant to Section 9.10; and issue a final Certificate for Payment pursuant to Section 9.10.

§ 4.2.10 If the Owner and Architect agree, the Architect will provide one or more Project representatives to assist in carrying out the Architect's responsibilities at the site. The Owner shall notify the Contractor of any change in the duties, responsibilities and limitations of authority of the Project representatives.

§ 4.2.11 The Architect will, in the first instance, interpret and decide matters concerning performance under, and requirements of, the Contract Documents on written request of either the Owner or Contractor. Upon receipt of such request, the Architect will promptly provide the other party with a copy of the request. The Architect's response to such requests will be made in writing within any time limits agreed upon or otherwise with reasonable promptness.

§ 4.2.12 Interpretations and decisions of the Architect will be consistent with the intent of, and reasonably inferable from, the Contract Documents and will be in writing or in the form of drawings. When making such interpretations and decisions, the Architect will endeavor to secure faithful performance by both Owner and Contractor, and will not show partiality to either. Except in the case of interpretations resulting in omissions, defects, or errors in the Instruments of Service or perpetuating omissions, defects or errors in the Instruments of Service, the Architect will not be liable for results of interpretations or decisions rendered in good faith. If either party disputes the Architect's interpretation or decision, that party may proceed as provided in Article 15. The Architect's interpretations and decisions may be, but need not be, accorded any deference in any review conducted pursuant to law or the Contract Documents.

§ 4.2.13 The Architect's decisions on matters relating to aesthetic effect will be final if consistent with the intent expressed in the Contract Documents.

§ 4.2.14 The Architect will review and respond to requests for information about the Contract Documents so as to avoid delay to the construction of the Project. The Architect's response to such requests will be made in writing with reasonable promptness. If appropriate, the Architect will prepare and issue supplemental Drawings and Specifications in response to the requests for information. Any response to a request for information must be consistent with the intent of, and reasonably inferable from, the Contract Documents and will be in writing or in the form of drawings.

Unless issued pursuant to a Modification, supplemental Drawings or Specifications will not involve an adjustment to the Contract Sum or Contract Time.

## **ARTICLE 5 SUBCONTRACTORS**

### **§ 5.1 Definitions**

**§ 5.1.1** A Subcontractor is a person or entity who has a direct contract with the Contractor to perform a portion of the Work at the site. The term “Subcontractor” is referred to throughout the Contract Documents as if singular in number and means a Subcontractor or an authorized representative of the Subcontractor. The term “Subcontractor” does not include a Separate Contractor or the subcontractors of a Separate Contractor.

**§ 5.1.2** A Sub-subcontractor is a person or entity who has a direct or indirect contract with a Subcontractor to perform a portion of the Work at the site. The term “Sub-subcontractor” is referred to throughout the Contract Documents as if singular in number and means a Sub-subcontractor or an authorized representative of the Sub-subcontractor.

### **§ 5.2 Award of Subcontracts and Other Contracts for Portions of the Work**

**§ 5.2.1** Unless otherwise stated in the Contract Documents, the Contractor, within fourteen (14) days after posting of the Notice of Intent to Award the Contract, shall notify the Owner and Architect of the persons or entities proposed for each principal portion of the Work, including those who are to furnish materials or equipment fabricated to a special design. Within 14 days of receipt of the information, the Owner may notify the Contractor whether the Owner has reasonable objection to any such proposed person or entity. Failure of the Owner to provide notice within the 14-day period shall constitute notice of no reasonable objection.

**§ 5.2.2** The Contractor shall not contract with a proposed person or entity to whom the Owner has made reasonable and timely objection. The Owner shall not direct the Contractor to contract with any specific individual or entity for supplies or services unless such supplies and services are necessary for completion of the Work and the specified individual or entity is the only source of such supply or service.

**§ 5.2.3** If the Owner has reasonable objection to a person or entity proposed by the Contractor, the Contractor shall propose another to whom the Owner has no reasonable objection. If the proposed but rejected Subcontractor was reasonably capable of performing the Work, the Contract Sum and Contract Time shall be increased or decreased by the difference, if any, occasioned by such change, and an appropriate Change Order shall be issued before commencement of the substitute Subcontractor’s Work. However, no increase in the Contract Sum or Contract Time shall be allowed for such change unless the Contractor has acted promptly and responsively in submitting names as required.

**§ 5.2.4** The Contractor shall not substitute a Subcontractor, person, or entity for one previously selected if the Owner makes reasonable objection to such substitution. The Contractor’s request for substitution must be made to the Owner in writing, accompanied by supporting information.

**§ 5.2.5** A Subcontractor identified in the Contractor’s Bid pursuant to the subcontractor listing requirements of Section 7 of the Bid Form may only be substituted in accordance with and as permitted by the provisions of S.C. Code Ann. § 11-35-3021. A proposed substitute for a listed subcontractor shall also be subject to the Owner’s approval as set forth in Section 5.2.3.

**§ 5.2.6** A Contractor may substitute one prospective subcontractor for another, with the approval of the Owner as follows:

- .1 If the Contractor requests the substitution, the Contractor is responsible for all costs associated with the substitution.
- .2 If the Owner requests the substitution, the Owner is responsible for any resulting increased costs to the Contractor.

### **§ 5.3 Subcontractual Relations**

**§ 5.3.1** By appropriate written agreement, the Contractor shall require each Subcontractor, to the extent of the Work to be performed by the Subcontractor, to be bound to the Contractor by terms of the Contract Documents, and to assume toward the Contractor all the obligations and responsibilities, including the responsibility for safety of the Subcontractor’s Work that the Contractor, by these Contract Documents, assumes toward the Owner and Architect. Each subcontract agreement shall preserve and protect the rights of the Owner and Architect under the Contract Documents with respect to the Work to be performed by the Subcontractor so that subcontracting thereof will not

Init.



prejudice such rights, and shall allow to the Subcontractor, unless specifically provided otherwise herein, or in the subcontract agreement, the benefit of all rights, remedies, and redress against the Contractor that the Contractor, by the Contract Documents, has against the Owner. Where appropriate, the Contractor shall require each Subcontractor to enter into similar agreements with Sub-subcontractors. The Contractor shall make available to each proposed Subcontractor, prior to the execution of the subcontract agreement, copies of the Contract Documents to which the Subcontractor will be bound, and, upon written request of the Subcontractor, identify to the Subcontractor terms and conditions of the proposed subcontract agreement that may be at variance with the Contract Documents. Subcontractors will similarly make copies of applicable portions of such documents available to their respective proposed Sub-subcontractors.

§ 5.3.2 Without limitation on the generality of Section 5.3.1, each Subcontract agreement and each Sub-subcontract agreement shall include, and shall be deemed to include, the following Sections of these General Conditions: 3.2, 3.5, 3.18, 5.3, 5.4, 6.2.2, 7.1.6, 7.3.3, 7.5, 13.1, 13.9, 14.3, 14.4, and 15.1.7.

§ 5.3.3 Each Subcontract Agreement and each Sub-subcontract agreement shall exclude, and shall be deemed to exclude, Sections 13.2 and 13.5 and all of Article 15, except Section 15.1.7, of these General Conditions. In the place of these excluded sections of the General Conditions, each Subcontract Agreement and each Sub-subcontract may include Sections 13.2 and 13.5 and all of Article 15, except Section 15.1.7, of AIA Document A201-2007, Conditions of the Contract, as originally issued by the American Institute of Architects.

§ 5.3.4 The Contractor shall assure the Owner that all agreements between the Contractor and its Subcontractor incorporate the provisions of Section 5.3.1 as necessary to preserve and protect the rights of the Owner and the Architect under the Contract Documents with respect to the work to be performed by Subcontractors so that the subcontracting thereof will not prejudice such rights. The Contractor's assurance shall be in the form of an affidavit or in such other form as the Owner may approve. Upon request, the Contractor shall provide the Owner or Architect with copies of any or all subcontracts or purchase orders.

#### § 5.4 Contingent Assignment of Subcontracts

§ 5.4.1 Each subcontract agreement for a portion of the Work is assigned by the Contractor to the Owner, provided that

- .1 assignment is effective only after termination of the Contract by the Owner for cause pursuant to Section 14.2 and only for those subcontract agreements that the Owner accepts by notifying the Subcontractor and Contractor; and
- .2 assignment is subject to the prior rights of the surety, if any, obligated under bond relating to the Contract.

§ 5.4.2 Upon such assignment, if the Work has been suspended for more than 30 days, the Subcontractor's compensation shall be equitably adjusted for increases in cost resulting from the suspension.

§ 5.4.3 Upon assignment to the Owner under this Section 5.4, the Owner may further assign the subcontract to a successor contractor or other entity. If the Owner assigns the subcontract to a successor contractor or other entity, the Owner shall nevertheless remain legally responsible for all of the successor contractor's obligations under the subcontract.

§ 5.4.4 Each subcontract shall specifically provide that the Owner shall only be responsible to the subcontractor for those obligations of the Contractor that accrue subsequent to the Owner's exercise of any rights under this conditional assignment.

§ 5.4.5 Each subcontract shall specifically provide that the Subcontractor agrees to perform portions of the Work assigned to the Owner in accordance with the Contract Documents.

§ 5.4.6 Nothing in this Section 5.4 shall act to reduce or discharge the Contractor's payment bond surety's obligations to claimants for claims arising prior to the Owner's exercise of any rights under this conditional assignment.

### ARTICLE 6 CONSTRUCTION BY OWNER OR BY SEPARATE CONTRACTORS

#### § 6.1 Owner's Right to Perform Construction and to Award Separate Contracts

§ 6.1.1 The term "Separate Contractor(s)" shall mean other contractors retained by the Owner under separate agreements. The Owner reserves the right to perform construction or operations related to the Project with the Owner's own forces, and with Separate Contractors retained under Conditions of the Contract substantially similar to

Init.

those of this Contract, including those provisions of the Conditions of the Contract related to insurance and waiver of subrogation.

§ 6.1.2 When separate contracts are awarded for different portions of the Project or other construction or operations on the site, the term “Contractor” in the Contract Documents in each case shall mean the Contractor who executes each separate Owner-Contractor Agreement.

§ 6.1.3 The Owner shall provide for coordination of the activities of the Owner’s own forces and of each Separate Contractor with the Work of the Contractor, who shall cooperate with them. The Contractor shall participate with any Separate Contractors and the Owner in reviewing their construction schedules. The Contractor shall make any revisions to its construction schedule deemed necessary after a joint review and mutual agreement. The construction schedules shall then constitute the schedules to be used by the Contractor, Separate Contractors, and the Owner until subsequently revised.

#### § 6.1.4 Reserved

### § 6.2 Mutual Responsibility

§ 6.2.1 The Contractor shall afford the Owner and Separate Contractors reasonable opportunity for introduction and storage of their materials and equipment and performance of their activities, and shall connect and coordinate the Contractor’s construction and operations with theirs as required by the Contract Documents.

§ 6.2.2 If part of the Contractor’s Work depends for proper execution or results upon construction or operations by the Owner or a Separate Contractor, the Contractor shall, prior to proceeding with that portion of the Work, promptly notify the Architect of apparent discrepancies or defects in the construction or operations by the Owner or Separate Contractor that would render it unsuitable for proper execution and results of the Contractor’s Work. Failure of the Contractor to notify the Architect of apparent discrepancies or defects prior to proceeding with the Work shall constitute an acknowledgment that the Owner’s or Separate Contractor’s completed or partially completed construction is fit and proper to receive the Contractor’s Work. The Contractor shall not be responsible for discrepancies or defects in the construction or operations by the Owner or Separate Contractor that are not apparent.

§ 6.2.3 The Contractor shall reimburse the Owner for costs the Owner incurs that are payable to a Separate Contractor because of the Contractor’s delays, improperly timed activities or defective construction. The Owner shall be responsible to the Contractor for costs the Contractor incurs because of a Separate Contractor’s delays, improperly timed activities, damage to the Work or defective construction.

§ 6.2.4 The Contractor shall promptly remedy damage that the Contractor wrongfully causes to completed or partially completed construction or to property of the Owner or Separate Contractor as provided in Section 10.2.5.

§ 6.2.5 The Owner and each Separate Contractor shall have the same responsibilities for cutting and patching as are described for the Contractor in Section 3.14.

### § 6.3 Owner’s Right to Clean Up

If a dispute arises among the Contractor, Separate Contractors, and the Owner as to the responsibility under their respective contracts for maintaining the premises and surrounding area free from waste materials and rubbish, the Owner may clean up and the Architect will allocate the cost among those responsible.

## ARTICLE 7 CHANGES IN THE WORK

### § 7.1 General

§ 7.1.1 Changes in the Work may be accomplished after execution of the Contract, and without invalidating the Contract, by Change Order, Construction Change Directive or order for a minor change in the Work, subject to the limitations stated in this Article 7 and elsewhere in the Contract Documents.

§ 7.1.2 A Change Order shall be based upon agreement among the Owner, Contractor, and Architect. A Construction Change Directive requires agreement by the Owner and Architect and may or may not be agreed to by the Contractor. An order for a minor change in the Work may be issued by the Architect alone.

§ 7.1.3 Changes in the Work shall be performed under applicable provisions of the Contract Documents. The Contractor shall proceed promptly with changes in the Work, unless otherwise provided in the Change Order, Construction Change Directive, or order for a minor change in the Work.

§ 7.1.4 If a change in the Work provides for an adjustment to the Contract Sum, the amount of such adjustment must be computed and documented in writing. In order to facilitate evaluation of proposals or claims for increases and decreases to the Contract Sum, all proposals or claims, except those so minor that their propriety can be seen by inspection, shall be accompanied by a complete itemization of costs including labor, materials and subcontracts. Labor and materials shall be itemized. Where major cost items are subcontracts, they shall be itemized also. The amount of the adjustment must approximate the actual cost to the Contractor and all costs incurred by the Contractor must be justifiably compared with prevailing industry standards. Except as provided in Section 7.1.5, all adjustments to the Contract Sum shall be limited to job specific costs and shall not include indirect costs, home office overhead or profit.

§ 7.1.5 The combined overhead and profit included in the total cost to the Owner for a change in the Work shall be based on the following schedule:

- .1 For the Contractor, for Work performed by the Contractor's own forces, not to exceed seventeen (17%) percent of the Contractor's actual costs.
- .2 For the Contractor, for Work performed by the Contractor's Subcontractors, not to exceed ten (10%) percent of each Subcontractor's actual costs (not including the Subcontractor's overhead and profit).
- .3 For each Subcontractor involved, for Work performed by that Subcontractor's own forces, not to exceed seventeen (17%) percent of the Subcontractor's actual costs.
- .4 Cost to which overhead and profit is to be applied shall be determined in accordance with Section 7.3.4.

The percentages cited above shall be considered to include all indirect costs including, but not limited to field and office managers, supervisors and assistants, incidental job burdens, small tools, and general overhead allocations.

§ 7.1.6 The procedures described in Sections 7.1.4 and 7.1.5 shall be used to calculate any adjustment in the Contract Sum, including without limitation an adjustment permitted under Articles 7, 9, 14, or 15.

§ 7.1.7 If a change in the Work requires an adjustment to the Contract Sum that exceeds the limits of the Owner's Construction Change Order Certification (reference Section 9.1.9 of the Agreement), then the Owner's agreement is not effective, and Work may not proceed until approved in writing by the OSE.

§ 7.1.8 Additional Work performed after the declaration of Substantial Completion must be approved by OSE, if the Change Order exceeds the Owner's Construction Change Order Certification.

## § 7.2 Change Orders

§ 7.2.1 A Change Order is a written instrument, using the OSE Construction Change Order form, prepared by the Architect and signed by the Owner, Contractor, and Architect stating their agreement upon all of the following:

- .1 The change in the Work;
- .2 The amount of the adjustment, if any, in the Contract Sum; and
- .3 The extent of the adjustment, if any, in the Contract Time.

Agreement on any Change Order shall constitute a final settlement of all matters relating to the change in the Work that is the subject of the Change Order, including, but not limited to, any adjustments to the Contract Sum or the Contract Time.

§ 7.2.2 At the Owner's request, the Contractor shall prepare a proposal to perform the work of a proposed Change Order setting forth the amount of the proposed adjustment, if any, in the Contract Sum; and the extent of the proposed adjustment, if any, in the Contract Time. Any proposed adjustment in the Contract Sum shall be prepared in accordance with Section 7.1.4 and 7.1.5. The Owner's request shall include any revisions to the Drawings or Specifications necessary to define any changes in the Work. Within fourteen (14) days of receiving the request, the Contractor shall submit the proposal to the Owner and Architect along with all documentation required by Section 7.5.

§ 7.2.3 If the Contractor requests a Change Order, the request shall set forth the proposed change in the Work and shall be prepared in accordance with Section 7.2.2. If the Contractor requests a change to the Work that involves a revision

Init.



to either the Drawings or Specifications, the Contractor shall reimburse the Owner for any expenditure associated with the Architects' review of the proposed revisions, except to the extent the revisions are accepted by execution of a Change Order.

### § 7.3 Construction Change Directives

§ 7.3.1 A Construction Change Directive is a written order prepared by the Architect and signed by the Owner and Architect, directing a change in the Work prior to agreement on adjustment, if any, in the Contract Sum or Contract Time, or both. The Owner may by Construction Change Directive, without invalidating the Contract, order changes in the Work within the general scope of the Contract consisting of additions, deletions, or other revisions, the Contract Sum and Contract Time being adjusted accordingly.

§ 7.3.2 A Construction Change Directive shall be used in the absence of total agreement on the terms of a Change Order.

§ 7.3.3 If the Construction Change Directive provides for an adjustment to the Contract Sum, the adjustment shall be based on one of the following methods:

- .1 Mutual acceptance of a lump sum if properly itemized and substantiating data is not available to permit evaluation;
- .2 Unit prices specified in the Contract Documents or subsequently agreed upon, subject to adjustment if any, as provided in Section 9.1.2;
- .3 Cost and a percentage fee, calculated as described in Sections 7.1.4 and 7.1.5;
- .4 in another manner as the parties may agree; or
- .5 As provided in Section 7.3.4.

§ 7.3.4 If the Contractor does not respond promptly or disagrees with the method for adjustment in the Contract Sum, the Architect shall make an initial determination, consistent with Section 7.3.3, of the method and the adjustment on the basis of reasonable expenditures and savings of those performing the Work attributable to the change, including, in case of an increase in the Contract Sum, an amount for overhead and profit as set forth in Section 7.1.5. In such case, and also under Section 7.3.3.3, the Contractor shall keep and present, in such form as the Architect may prescribe, an itemized accounting together with appropriate supporting data. Unless otherwise provided in the Contract Documents, costs for the purposes of this Section 7.3.4 shall be limited to the following:

- .1 Costs of labor, including applicable payroll taxes, fringe benefits required by agreement or custom, workers' compensation insurance, and other employee costs approved by the Architect;
- .2 Costs of materials, supplies, and equipment, including cost of transportation, whether incorporated or consumed;
- .3 Rental costs of machinery and equipment, exclusive of hand tools, whether rented from the Contractor or others; and
- .4 Costs of premiums for all bonds and insurance, permit fees, and sales, use, or similar taxes, directly related to the change.

§ 7.3.5 If the Contractor disagrees with the adjustment in the Contract Time, the Contractor may make a Claim in accordance with applicable provisions of Article 15.

§ 7.3.6 Upon receipt of a Construction Change Directive, the Contractor shall promptly proceed with the change in the Work involved and advise the Architect of the Contractor's agreement or disagreement with the method, if any, provided in the Construction Change Directive for determining the proposed adjustment in the Contract Sum or Contract Time.

§ 7.3.7 A Construction Change Directive signed by the Contractor indicates the Contractor's agreement therewith, including adjustment in Contract Sum and Contract Time or the method for determining them. Such agreement shall be effective immediately and shall be recorded as a Change Order.

§ 7.3.8 The amount of credit to be allowed by the Contractor to the Owner for a deletion or change that results in a net decrease in the Contract Sum shall be actual cost including overhead and profit as confirmed by the Architect from the Schedule of Values.

§ 7.3.9 Pending final determination of the total cost of a Construction Change Directive to the Owner, the Contractor may request payment for Work completed under the Construction Change Directive in Applications for Payment. The

Init.

Architect will make an interim determination for purposes of monthly certification for payment for those costs and certify for payment the amount that the Architect determines, in the Architect's professional judgment, to be reasonably justified. The Architect's interim determination of cost shall adjust the Contract Sum on the same basis as a Change Order, subject to the right of either party to disagree and assert a Claim in accordance with Article 15.

§ 7.3.10 When the Owner and Contractor agree with a determination made by the Architect concerning the adjustments in the Contract Sum and Contract Time, or otherwise reach agreement upon the adjustments, such agreement shall be effective immediately and the Architect will prepare a Change Order. Change Orders may be issued for all or any part of a Construction Change Directive.

#### § 7.4 Minor Changes in the Work

The Architect may order minor changes in the Work that are consistent with the intent of the Contract Documents and do not involve an adjustment in the Contract Sum or an extension of the Contract Time. The Architect's order for minor changes shall be in writing. If the Contractor believes that the proposed minor change in the Work will affect the Contract Sum or Contract Time, the Contractor shall notify the Architect and shall not proceed to implement the change in the Work. If the Contractor performs the Work set forth in the Architect's order for a minor change without prior notice to the Architect that such change will affect the Contract Sum or Contract Time, the Contractor waives any adjustment to the Contract Sum or extension of the Contract Time.

#### § 7.5 Pricing Data and Audit

##### § 7.5.1 Cost or Pricing Data

Upon request of the Owner or Architect, Contractor shall submit cost or pricing data prior to execution of a Modification which exceeds \$500,000 [Reference S.C. Code Ann. §§ 11-35-1830 and 11-35-2220, and SC Code Ann. Reg 19-445.2120]. Contractor shall certify that, to the best of its knowledge and belief, the cost or pricing data submitted is accurate, complete, and current as of a mutually determined specified date prior to the date of pricing the Modification. Contractor's price, including profit, shall be adjusted to exclude any significant sums by which such price was increased because Contractor furnished cost or pricing data that was inaccurate, incomplete, or not current as of the date specified by the parties. Notwithstanding Subparagraph 9.10.4, such adjustments may be made after final payment to the Contractor.

§ 7.5.2 Cost or pricing data means all facts that, as of the date specified by the parties, prudent buyers and sellers would reasonably expect to affect price negotiations significantly. Cost or pricing data are factual, not judgmental; and are verifiable. While they do not indicate the accuracy of the prospective contractor's judgment about estimated future costs or projections, they do include the data forming the basis for that judgment. Cost or pricing data are more than historical accounting data; they are all the facts that can be reasonably expected to contribute to the soundness of estimates of future costs and to the validity of determinations of costs already incurred.

##### § 7.5.3 Records Retention

As used in Section 7.5, the term "Records" means any books or records that relate to cost or pricing data of a Change Order that Contractor is required to submit pursuant to Section 7.5.1. Contractor shall maintain records for three years from the date of final payment, or longer if requested by the chief procurement officer. The Owner may audit Contractor's records at reasonable times and places.

### ARTICLE 8 TIME

#### § 8.1 Definitions

§ 8.1.1 Unless otherwise provided, Contract Time is the period of time, including authorized adjustments, allotted in the Contract Documents for Substantial Completion of the Work.

§ 8.1.2 The date of commencement of the Work is the date established in the Agreement.

§ 8.1.3 The date of Substantial Completion is the date certified by the Architect in accordance with Section 9.8.

§ 8.1.4 The term "day" as used in the Contract Documents shall mean calendar day unless otherwise specifically defined.

#### § 8.2 Progress and Completion

§ 8.2.1 Time limits stated in the Contract Documents are of the essence of the Contract. By executing the Agreement, the Contractor confirms that the Contract Time is a reasonable period for performing the Work.

Init.

§ 8.2.2 The Contractor shall not knowingly commence the Work prior to the effective date of surety bonds and insurance required to be furnished by the Contractor and Owner.

§ 8.2.3 The Contractor shall proceed expeditiously with adequate forces and shall achieve Substantial Completion within the Contract Time.

### § 8.3 Delays and Extensions of Time

§ 8.3.1 If the Contractor is delayed at any time in the commencement or progress of the Work by (1) an act or neglect of the Owner or Architect, of an employee of either, or of a Separate Contractor; (2) by changes ordered in the Work; (3) by labor disputes, fire, unusual delay in deliveries, unavoidable casualties, adverse weather conditions documented in accordance with Section 15.1.6.2, or other causes beyond the Contractor's control; (4) by delay authorized by the Owner pending dispute resolution; or (5) by other causes that the Contractor asserts, and the Architect determines, justify delay, then to the extent such delay will prevent the Contractor from achieving Substantial Completion within the Contract Time, the Contract Time shall be extended for such reasonable time as the Architect may determine, provided the delay:

- .1 is not caused by the fault or negligence of the Contractor or a subcontractor at any tier, and
- .2 is not due to unusual delay in the delivery of supplies, machinery, equipment, or services when such supplies, machinery, equipment, or services were obtainable from other sources in sufficient time for the Contractor to meet the required delivery.

§ 8.3.2 Claims relating to time shall be made in accordance with applicable provisions of Article 15.

§ 8.3.3 This Section 8.3 does not preclude recovery of damages for delay by either party under other provisions of the Contract Documents.

## ARTICLE 9 PAYMENTS AND COMPLETION

### § 9.1 Contract Sum

§ 9.1.1 The Contract Sum is stated in the Agreement and, including authorized adjustments, is the total amount payable by the Owner to the Contractor for performance of the Work under the Contract Documents.

§ 9.1.2 If unit prices are stated in the Contract Documents or subsequently agreed upon, and if quantities originally contemplated are materially changed so that application of such unit prices to the actual quantities causes substantial inequity to the Owner or Contractor, the applicable unit prices shall be equitably adjusted.

### § 9.2 Schedule of Values

§ 9.2.1 The Contractor shall submit a schedule of values to the Architect within ten (10) days of full execution of the Agreement, allocating the entire Contract Sum to the various portions of the Work. The schedule of values shall be prepared in the form, and supported by the data to substantiate its accuracy, required by the Architect. This schedule, unless objected to by the Architect, shall be used as a basis for reviewing the Contractor's Applications for Payment. Any changes to the schedule of values shall be submitted to the Architect and supported by such data to substantiate its accuracy as the Architect may require, and unless objected to by the Architect, shall be used as a basis for reviewing the Contractor's subsequent Applications for Payment.

§ 9.2.2 As requested by the Architect, the Contractor and each Subcontractor shall prepare a trade payment breakdown for the Work for which each is responsible. The breakdown, being submitted on a uniform standardized format approved by the Architect and Owner, shall be divided in detail, using convenient units, sufficient to accurately determine the value of completed Work during the course of the Project. The Contractor shall update the schedule of values as required by either the Architect or Owner as necessary to reflect:

- .1 the description of Work (listing labor and material separately);
- .2 the total value of the Work;
- .3 the percent and value of the Work completed to date;
- .4 the percent and value of previous amounts billed; and
- .5 the current percent completed, and amount billed.

§ 9.2.3 Any schedule of values or trade breakdown that fails to provide sufficient detail, is unbalanced, or exhibits "front-loading" of the value of the Work shall be rejected. If a schedule of values or trade breakdown is used as the basis for payment and later determined to be inaccurate, sufficient funds shall be withheld from future Applications for Payment to ensure an adequate reserve (exclusive of normal retainage) to complete the Work.

### § 9.3 Applications for Payment

§ 9.3.1 Monthly, the Contractor shall submit to the Architect an itemized Application for Payment prepared in accordance with the schedule of values, if required under Section 9.2, for completed portions of the Work. The application shall be notarized, if required, and supported by all data substantiating the Contractor's right to payment that the Owner or Architect require (such as copies of requisitions, and releases and waivers of liens from Subcontractors and suppliers), and shall reflect retainage as provided for in the Contract Documents.

§ 9.3.1.1 As provided in Section 7.3.9, such applications may include requests for payment on account of changes in the Work that have been properly authorized by Construction Change Directives, or by interim determinations of the Architect, but not yet included in Change Orders.

§ 9.3.1.2 Applications for Payment shall not include requests for payment for portions of the Work for which the Contractor does not intend to pay a Subcontractor or supplier, unless such Work has been performed by others whom the Contractor intends to pay.

§ 9.3.2 Unless otherwise provided in the Contract Documents, payments shall be made on account of materials and equipment delivered and suitably stored at the site for subsequent incorporation in the Work. If approved in advance by the Owner, payment may similarly be made for materials and equipment suitably stored off the site at a location agreed upon in writing, provided such materials or equipment will be subsequently incorporated in the Work. Payment for materials and equipment stored on or off the site shall be conditioned upon compliance by the Contractor with procedures satisfactory to the Owner to establish the Owner's title to such materials and equipment or otherwise protect the Owner's interest, and shall include the costs of applicable insurance, storage, and transportation to the site, for such materials and equipment stored off the site. The Contractor shall 1) protect such materials from diversion, vandalism, theft, destruction, and damage, 2) mark such materials specifically for use on the Project, and 3) segregate such materials from other materials at the storage facility. The Architect and the Owner shall have the right to make inspections of the storage areas at any time.

§ 9.3.3 The Contractor warrants that title to all Work covered by an Application for Payment will pass to the Owner no later than the time of payment. The Contractor further warrants that upon submittal of an Application for Payment all Work for which Certificates for Payment have been previously issued and payments received from the Owner shall, to the best of the Contractor's knowledge, information, and belief, be free and clear of liens, claims, security interests, or encumbrances, in favor of the Contractor, Subcontractors, suppliers, or other persons or entities that provided labor, materials, and equipment relating to the Work.

### § 9.4 Certificates for Payment

§ 9.4.1 The Architect will, within seven days after receipt of the Contractor's Application for Payment, either (1) issue to the Owner a Certificate for Payment in the full amount of the Application for Payment, with a copy to the Contractor; or (2) issue to the Owner a Certificate for Payment for such amount as the Architect determines is properly due, and notify the Contractor and Owner of the Architect's reasons for withholding certification in part as provided in Section 9.5.1; or (3) withhold certification of the entire Application for Payment, and notify the Contractor and Owner of the Architect's reason for withholding certification in whole as provided in Section 9.5.1.

§ 9.4.2 The issuance of a Certificate for Payment will constitute a representation by the Architect to the Owner, based on the Architect's evaluation of the Work and the data in the Application for Payment, that, to the best of the Architect's knowledge, information, and belief, the Work has progressed to the point indicated in both the Application for Payment and, if required to be submitted, the accompanying current construction schedule, the quality of the Work is in accordance with the Contract Documents, and that the Contractor is entitled to payment in the amount certified. The foregoing representations are subject to an evaluation of the Work for conformance with the Contract Documents upon Substantial Completion, to results of subsequent tests and inspections, to correction of minor deviations from the Contract Documents prior to completion, and to specific qualifications expressed by the Architect. However, the issuance of a Certificate for Payment will not be a representation that the Architect has (1) made exhaustive or continuous on-site inspections to check the quality or quantity of the Work; (2) reviewed construction means,

methods, techniques, sequences, or procedures; or (3) made examination to ascertain how or for what purpose the Contractor has used money previously paid on account of the Contract Sum.

### § 9.5 Decisions to Withhold Certification

§ 9.5.1 The Architect shall withhold a Certificate for Payment in whole or in part, to the extent reasonably necessary to protect the Owner, if in the Architect's opinion the representations to the Owner required by Section 9.4.2 cannot be made. The Architect shall withhold a Certificate of Payment if the Application for Payment is not accompanied by the current construction schedule required by Section 3.10.1. If the Architect is unable to certify payment in the amount of the Application, the Architect will notify the Contractor and Owner as provided in Section 9.4.1. If the Contractor and Architect cannot agree on a revised amount, the Architect will promptly issue a Certificate for Payment for the amount for which the Architect is able to make such representations to the Owner. The Architect may also withhold a Certificate for Payment or, because of subsequently discovered evidence, may nullify the whole or a part of a Certificate for Payment previously issued, to such extent as may be necessary in the Architect's opinion to protect the Owner from loss for which the Contractor is responsible, including loss resulting from acts and omissions described in Section 3.3.2, because of

- .1 defective Work not remedied;
- .2 third party claims filed or reasonable evidence indicating probable filing of such claims, unless security acceptable to the Owner is provided by the Contractor;
- .3 failure of the Contractor to make payments properly to Subcontractors or suppliers for labor, materials or equipment;
- .4 reasonable evidence that the Work cannot be completed for the unpaid balance of the Contract Sum;
- .5 damage to the Owner or a Separate Contractor;
- .6 reasonable evidence that the Work will not be completed within the Contract Time, and that the unpaid balance would not be adequate to cover actual or liquidated damages for the anticipated delay; or
- .7 repeated failure to carry out the Work in accordance with the Contract Documents.

§ 9.5.2 When either party disputes the Architect's decision regarding a Certificate for Payment under Section 9.5.1, in whole or in part, that party may submit a Claim in accordance with Article 15.

§ 9.5.3 When the reasons for withholding certification are removed, certification will be made for amounts previously withheld.

§ 9.5.4 If the Architect withholds certification for payment under Section 9.5.1.3, the Owner may, at its sole option, issue joint checks to the Contractor and to any Subcontractor or supplier to whom the Contractor failed to make payment for Work properly performed or material or equipment suitably delivered. If the Owner makes payments by joint check, the Owner shall notify the Architect and the Contractor shall reflect such payment on its next Application for Payment.

### § 9.6 Progress Payments

§ 9.6.1 After the Architect has issued a Certificate for Payment, the Owner shall make payment in the manner and within the time provided in the Contract Documents, and shall so notify the Architect.

§ 9.6.2 Pursuant to S.C. Ann. §§ 29-6-10 through 29-6-60, the Contractor shall pay each Subcontractor, no later than seven days after receipt of payment from the Owner, the amount to which the Subcontractor is entitled, reflecting percentages actually retained from payments to the Contractor on account of the Subcontractor's portion of the Work. The Contractor shall, by appropriate agreement with each Subcontractor, require each Subcontractor to make payments to Sub-subcontractors in a similar manner.

§ 9.6.3 The Architect will, on request, furnish to a Subcontractor, if practicable, information regarding percentages of completion or amounts applied for by the Contractor and action taken thereon by the Architect and Owner on account of portions of the Work done by such Subcontractor.

§ 9.6.4 The Owner has the right to request written evidence from the Contractor that the Contractor has properly paid Subcontractors and suppliers amounts paid by the Owner to the Contractor for subcontracted Work. If the Contractor fails to furnish such evidence within seven days, the Owner shall have the right to contact Subcontractors and suppliers to ascertain whether they have been properly paid. Neither the Owner nor Architect shall have an obligation to pay, or to see to the payment of money to, a Subcontractor or supplier, except as may otherwise be required by law.



§ 9.6.5 The Contractor's payments to suppliers shall be treated in a manner similar to that provided in Sections 9.6.2, 9.6.3 and 9.6.4.

§ 9.6.6 A Certificate for Payment, a progress payment, or partial or entire use or occupancy of the Project by the Owner shall not constitute acceptance of Work not in accordance with the Contract Documents.

§ 9.6.7 Unless the Contractor provides the Owner with a payment bond in the full penal sum of the Contract Sum, payments received by the Contractor for Work properly performed by Subcontractors or provided by suppliers shall be held by the Contractor for those Subcontractors or suppliers who performed Work or furnished materials, or both, under contract with the Contractor for which payment was made by the Owner. Nothing contained herein shall require money to be placed in a separate account and not commingled with money of the Contractor, create any fiduciary liability or tort liability on the part of the Contractor for breach of trust, or entitle any person or entity to an award of punitive damages against the Contractor for breach of the requirements of this provision.

§ 9.6.8 Provided the Owner has fulfilled its payment obligations under the Contract Documents, the Contractor shall defend and indemnify the Owner from all loss, liability, damage or expense, including reasonable attorney's fees and litigation expenses, arising out of any lien claim or other claim for payment by any Subcontractor or supplier of any tier. Upon receipt of notice of a lien claim or other claim for payment, the Owner shall notify the Contractor. If approved by the applicable court, when required, the Contractor may substitute a surety bond for the property against which the lien or other claim for payment has been asserted.

### § 9.7 Failure of Payment

If the Architect does not issue a Certificate for Payment to the Owner, through no fault of the Contractor, within seven days after receipt of the Contractor's Application for Payment, or if the Owner does not pay the Contractor within seven days after the time established in the Contract Documents, the amount certified by the Architect or awarded by final dispute resolution order, then the Contractor may, upon seven additional days' notice to the Owner and Architect, stop the Work until payment of the amount owing has been received. The Contract Time shall be extended appropriately and the Contract Sum shall be increased by the amount of the Contractor's reasonable costs of shutdown, delay and start-up, plus interest as provided for in the Contract Documents.

### § 9.8 Substantial Completion

§ 9.8.1 Substantial Completion is the stage in the progress of the Work when the Work or designated portion thereof is sufficiently complete in accordance with the Contract Documents so that the Owner can occupy or utilize the Work for its intended use.

§ 9.8.2 When the Contractor considers that the Work, or a portion thereof which the Owner agrees to accept separately, is substantially complete, the Contractor shall prepare and submit to the Architect a comprehensive written list of items to be completed or corrected prior to final payment. Failure to include an item on such list does not alter the responsibility of the Contractor to complete all Work in accordance with the Contract Documents.

§ 9.8.3 Upon receipt of the Contractor's list, the Architect, the Owner, and any other party the Architect or the Owner choose, will make an inspection on a date and at a time mutually agreeable to determine whether the Work or designated portion thereof is substantially complete. The Contractor shall furnish access for the inspection and testing as provided in this Contract. The inspection shall include a demonstration by the Contractor that all equipment, systems and operable components of the Work function properly and in accordance with the Contract Documents.

- .1 If the Architect's inspection discloses any item, whether or not included on the Contractor's list, which is not sufficiently complete in accordance with the Contract Documents so that the Owner can occupy or utilize the Work or designated portion thereof for its intended use, the Contractor shall, before issuance of the Certificate of Substantial Completion, complete or correct such item upon notification by the Architect. In such case, the Contractor shall then submit a request for another inspection by the Architect to determine Substantial Completion.
- .2 If more than one Substantial Completion inspection is required, the Contractor shall reimburse the Owner for all costs of re-inspections or, at the Owner's option, the costs may be deducted from payments due to the Contractor.
- .3 Representatives of the State Fire Marshal's Office and other authorities having jurisdiction may be present at the Substantial Completion inspection or otherwise inspect the completed Work and advise the Owner whether the Work meets their respective requirements for the Project.

§ 9.8.4 When the Work or designated portion thereof is substantially complete, the Architect will prepare a Certificate of Substantial Completion that shall establish the date of Substantial Completion; establish responsibilities of the Owner and Contractor for security, maintenance, heat, utilities, damage to the Work and insurance; and fix the time within which the Contractor shall finish all items on the list accompanying the Certificate. Warranties required by the Contract Documents shall commence on the date of Substantial Completion of the Work or designated portion thereof unless otherwise provided in the Certificate of Substantial Completion.

§ 9.8.5 The Certificate of Substantial Completion shall be submitted to the Owner for its written acceptance of responsibilities assigned in the Certificate and a copy of the signed Certificate shall be delivered to the Contractor. Upon such acceptance, the Owner shall make payment of retainage applying to the Work or designated portion thereof. Such payment shall be adjusted for Work that is incomplete or not in accordance with the requirements of the Contract Documents.

§ 9.8.6 If the Architect and Owner concur in the Contractor's assessment that the Work or a portion of the Work is safe to occupy, the Owner and Contractor may arrange for a Certificate of Occupancy inspection by OSE. The Owner, Architect, and Contractor shall be present at OSE's inspection. Upon verifying that the Work or a portion of the Work is substantially complete and safe to occupy, OSE will issue, as appropriate, a Full or Partial Certificate of Occupancy.

§ 9.8.7 The Owner may not occupy the Work until all required occupancy permits, if any, have been issued and delivered to the Owner.

### § 9.9 Partial Occupancy or Use

§ 9.9.1 The Owner may occupy or use any completed or partially completed portion of the Work at any stage when such portion is designated by separate agreement with the Contractor, provided such occupancy or use is consented to by the insurer and authorized by public authorities having jurisdiction over the Project. Such partial occupancy or use may commence whether or not the portion is substantially complete, provided the Owner and Contractor have accepted in writing the responsibilities assigned to each of them for payments, retainage, if any, security, maintenance, heat, utilities, damage to the Work and insurance, and have agreed in writing concerning the period for correction of the Work and commencement of warranties required by the Contract Documents. When the Contractor considers a portion substantially complete, the Contractor shall prepare and submit a list to the Architect as provided under Section 9.8.2. Consent of the Contractor to partial occupancy or use shall not be unreasonably withheld. The stage of the progress of the Work shall be determined by written agreement between the Owner and Contractor or, if no agreement is reached, by decision of the Architect.

§ 9.9.2 Immediately prior to such partial occupancy or use, the Owner, Contractor, and Architect shall jointly inspect the area to be occupied or portion of the Work to be used in order to determine and record the condition of the Work.

§ 9.9.3 Unless otherwise agreed upon, partial occupancy or use of a portion or portions of the Work shall not constitute acceptance of Work not complying with the requirements of the Contract Documents.

### § 9.10 Final Completion and Final Payment

§ 9.10.1 Unless the parties agree otherwise in the Certificate of Substantial Completion, the Contractor shall achieve Final Completion within thirty days after Substantial Completion. Upon receipt of the Contractor's notice that the Work is ready for final inspection and acceptance and upon receipt of a final Application for Payment, the Architect, the Owner, and any other party the Architect or the Owner choose will make an inspection on a date and at a time mutually agreeable. When the Architect finds the Work acceptable under the Contract Documents and the Contract fully performed, the Architect will promptly issue a final Certificate for Payment stating that to the best of the Architect's knowledge, information and belief, and on the basis of the Architect's on-site visits and inspections, the Work has been completed in accordance with the Contract Documents and that the entire balance found to be due the Contractor and noted in the final Certificate is due and payable. The Architect's final Certificate for Payment will constitute a further representation that conditions listed in Section 9.10.2 as precedent to the Contractor's being entitled to final payment have been fulfilled.

- .1 If more than one Final Completion inspection is required, the Contractor shall reimburse the Owner for all costs of re-inspections or, at the Owner's option, the costs may be deducted from payments due to the Contractor.
- .2 If the Contractor does not achieve Final Completion within thirty days after Substantial Completion or the timeframe agreed to by the parties in the Certificate of Substantial Completion, whichever is

greater, the Contractor shall be responsible for any additional Architectural fees resulting from the delay.

- .3 If OSE has not previously issued a Certificate of Occupancy for the entire Project, the Parties shall arrange for a representative of OSE to participate in the Final Completion inspection.

§ 9.10.2 Neither final payment nor any remaining retained percentage shall become due until the Contractor submits to the Architect:

- .1 an affidavit that payrolls, bills for materials and equipment, and other indebtedness connected with the Work for which the Owner or the Owner's property might be responsible or encumbered (less amounts withheld by Owner) have been paid or otherwise satisfied,
- .2 a certificate evidencing that insurance required by the Contract Documents to remain in force after final payment is currently in effect,
- .3 a written statement that the Contractor knows of no reason that the insurance will not be renewable to cover the period required by the Contract Documents,
- .4 consent of surety, if any, to final payment,
- .5 documentation of any special warranties, such as manufacturers' warranties or specific Subcontractor warranties,
- .6 if required by the Owner, other data establishing payment or satisfaction of obligations, such as receipts and releases and waivers of liens, claims, security interests, or encumbrances arising out of the Contract, to the extent and in such form as may be designated by the Owner,
- .7 required Training Manuals,
- .8 equipment Operations and Maintenance Manuals,
- .9 any certificates of testing, inspection or approval required by the Contract Documents and not previously provided, and
10. one copy of the Documents required by Section 3.11.

§ 9.10.3 If, after Substantial Completion of the Work, final completion thereof is delayed 60 days through no fault of the Contractor or by issuance of Change Orders affecting final completion, and the Architect so confirms, the Owner shall, upon application by the Contractor and certification by the Architect, and without terminating the Contract, make payment of the balance due for that portion of the Work fully completed, corrected, and accepted. If the remaining balance for Work not fully completed or corrected is less than retainage stipulated in the Contract Documents, and if bonds have been furnished, the written consent of the surety to payment of the balance due for that portion of the Work fully completed and accepted shall be submitted by the Contractor to the Architect prior to certification of such payment. Such payment shall be made under terms and conditions governing final payment, except that it shall not constitute a waiver of Claims.

§ 9.10.4 The making of final payment shall constitute a waiver of Claims by the Owner except those arising from

- .1 liens, Claims, security interests, or encumbrances arising out of the Contract and unsettled;
- .2 failure of the Work to comply with the requirements of the Contract Documents;
- .3 terms of special warranties required by the Contract Documents; or
- .4 audits performed by the Owner, if permitted by the Contract Documents, after final payment.

§ 9.10.5 Acceptance of final payment by the Contractor, a Subcontractor, or a supplier, shall constitute a waiver of claims by that payee except those specific claims in stated amounts that have been previously made in writing and identified by that payee as unsettled at the time of final Application for Payment.

## ARTICLE 10 PROTECTION OF PERSONS AND PROPERTY

### § 10.1 Safety Precautions and Programs

The Contractor shall be responsible for initiating, maintaining, and supervising all safety precautions and programs in connection with the performance of the Contract.

### § 10.2 Safety of Persons and Property

§ 10.2.1 The Contractor shall take reasonable precautions for safety of, and shall provide reasonable protection to prevent damage, injury, or loss to

- .1 employees on the Work and other persons who may be affected thereby;
- .2 the Work and materials and equipment to be incorporated therein, whether in storage on or off the site, under care, custody, or control of the Contractor, a Subcontractor, or a Sub-subcontractor; and



- 3 other property at the site or adjacent thereto, such as trees, shrubs, lawns, walks, pavements, roadways, structures, and utilities not designated for removal, relocation, or replacement in the course of construction.

§ 10.2.2 The Contractor shall comply with, and give notices required by applicable laws, statutes, ordinances, codes, rules and regulations, and lawful orders of public authorities, bearing on safety of persons or property or their protection from damage, injury, or loss.

§ 10.2.3 The Contractor shall implement, erect, and maintain, as required by existing conditions and performance of the Contract, reasonable safeguards for safety and protection, including posting danger signs and other warnings against hazards; promulgating safety regulations; and notifying the owners and users of adjacent sites and utilities of the safeguards.

§ 10.2.4 When use or storage of explosives or other hazardous materials or equipment, or unusual methods are necessary for execution of the Work, the Contractor shall exercise utmost care and carry on such activities under supervision of properly qualified personnel.

§ 10.2.5 The Contractor shall promptly remedy damage and loss (other than damage or loss insured under property insurance required by the Contract Documents) to property referred to in Sections 10.2.1.2 and 10.2.1.3 caused in whole or in part by the Contractor, a Subcontractor, a Sub-subcontractor, or anyone directly or indirectly employed by any of them, or by anyone for whose acts they may be liable and for which the Contractor is responsible under Sections 10.2.1.2 and 10.2.1.3. The Contractor may make a Claim for the cost to remedy the damage or loss to the extent such damage or loss is attributable to acts or omissions of the Owner or Architect or anyone directly or indirectly employed by either of them, or by anyone for whose acts either of them may be liable, and not attributable to the fault or negligence of the Contractor. The foregoing obligations of the Contractor are in addition to the Contractor's obligations under Section 3.18.

§ 10.2.6 The Contractor shall designate a responsible member of the Contractor's organization at the site whose duty shall be the prevention of accidents. This person shall be the Contractor's superintendent unless otherwise designated by the Contractor in writing to the Owner and Architect.

§ 10.2.7 The Contractor shall not permit any part of the construction or site to be loaded so as to cause damage or create an unsafe condition.

#### § 10.2.8 Injury or Damage to Person or Property

If either party suffers injury or damage to person or property because of an act or omission of the other party, or of others for whose acts such party is legally responsible, notice of the injury or damage, whether or not insured, shall be given to the other party within a reasonable time not exceeding 21 days after discovery. The notice shall provide sufficient detail to enable the other party to investigate the matter.

#### § 10.3 Hazardous Materials and Substances

§ 10.3.1 The Contractor is responsible for compliance with any requirements included in the Contract Documents regarding hazardous materials or substances. If the Contractor encounters a hazardous material or substance which was not discoverable as provided in Section 3.2.1 and not addressed in the Contract Documents, and if reasonable precautions will be inadequate to prevent foreseeable bodily injury or death to persons or serious loss to real or personal property resulting from such a material or substance encountered on the site by the Contractor, the Contractor shall, upon recognizing the condition, immediately stop Work in the affected area and notify the Owner and Architect of the condition. Hazardous materials or substances are those hazardous, toxic, or radioactive materials or substances subject to regulations by applicable governmental authorities having jurisdiction, such as, but not limited to, the S.C. Department of Health and Environmental Control, the U.S. Environmental Protection Agency, and the U.S. Nuclear Regulatory Commission.

§ 10.3.2 Upon receipt of the Contractor's notice, the Owner shall obtain the services of a licensed laboratory to verify the presence or absence of the material or substance reported by the Contractor and, in the event such material or substance is found to be present, to cause it to be rendered harmless. Unless otherwise required by the Contract Documents, the Owner shall furnish in writing to the Contractor and Architect the names and qualifications of persons or entities who are to perform tests verifying the presence or absence of the material or substance or who are to perform the task of removal or safe containment of the material or substance. The Contractor and the Architect will

Init.

promptly reply to the Owner in writing stating whether or not either has reasonable objection to the persons or entities proposed by the Owner. If either the Contractor or Architect has an objection to a person or entity proposed by the Owner, the Owner shall propose another to whom the Contractor and the Architect have no reasonable objection. When the material or substance has been rendered harmless, Work in the affected area shall resume upon written agreement of the Owner and Contractor. By Change Order, the Contract Time shall be extended appropriately and the Contract Sum shall be increased by the amount of the Contractor's reasonable additional costs of shutdown, delay, and start-up. In the absence of agreement, the Architect will make an interim determination regarding any delay or impact on the Contractor's additional costs. The Architect's interim determination of cost shall adjust the Contract Sum on the same basis as a Change Order, subject to the rights of either party to disagree and assert a Claim in accordance with Article 15.

**§ 10.3.3** The Work in the affected area shall be resumed immediately following the occurrence of any one of the following events: (a) the Owner causes remedial work to be performed that results in the absence of hazardous materials or substances; (b) the Owner and the Contractor, by written agreement, decide to resume performance of the Work; or (c) the Work may safely and lawfully proceed, as determined by an appropriate governmental authority or as evidenced by a written report to both the Owner and the Contractor, which is prepared by an environmental engineer reasonably satisfactory to both the Owner and the Contractor.

**§ 10.3.4** The Owner shall not be responsible under this Section 10.3 for hazardous materials or substances the Contractor brings to the site unless such materials or substances are required by the Contract Documents. The Owner shall be responsible for hazardous materials or substances required by the Contract Documents, except to the extent of the Contractor's fault or negligence in the use and handling of such materials or substances.

**§ 10.3.5** In addition to its obligations under Section 3.18, the Contractor shall reimburse the Owner for the cost and expense the Owner incurs (1) for remediation of hazardous materials or substances the Contractor brings to the site and negligently handles, or (2) where the Contractor fails to perform its obligations under Section 10.3.1, except to the extent that the cost and expense are due to the Owner's fault or negligence.

#### **§ 10.3.6 Reserved**

#### **§ 10.4 Emergencies**

In an emergency affecting safety of persons or property, the Contractor shall act, at the Contractor's discretion, to prevent threatened damage, injury, or loss. Additional compensation or extension of time claimed by the Contractor on account of an emergency shall be determined as provided in Article 15 and Article 7. The Contractor shall immediately give the Owner and Architect notice of the emergency. This initial notice may be oral followed within five (5) days by a written notice setting forth the nature and scope of the emergency. Within fourteen (14) days of the start of the emergency, the Contractor shall give the Architect a written estimate of the cost and probable effect of delay on the progress of the Work.

### **ARTICLE 11 INSURANCE AND BONDS**

#### **§ 11.1 Contractor's Insurance and Bonds**

**§ 11.1.1** The Contractor shall purchase and maintain insurance of the types and limits of liability, containing the endorsements, and subject to the terms and conditions, as described in the Agreement or elsewhere in the Contract Documents. The Contractor shall purchase and maintain the required insurance from an insurance company or insurance companies lawfully authorized to issue insurance in the jurisdiction where the Project is located. The Owner, Architect, and Architect's consultants shall be named as additional insureds under the Contractor's commercial general liability policy or as otherwise described in the Contract Documents.

**§ 11.1.2** The Contractor shall provide surety bonds of the types, for such penal sums, and subject to such terms and conditions as required by the Contract Documents. The Contractor shall purchase and maintain the required bonds from a company or companies lawfully authorized to issue surety bonds in the jurisdiction where the Project is located.

**§ 11.1.3** Upon the request of any person or entity appearing to be a potential beneficiary of bonds covering payment of obligations arising under the Contract, the Contractor shall promptly furnish a copy of the bonds or shall authorize a copy to be furnished.

**§ 11.1.4 Failure to Purchase Required Property Insurance.** If the Contractor fails to purchase and maintain the required property insurance, with all of the coverages and in the amounts described in the Agreement or elsewhere in the

Contract Documents, the Contractor shall inform the Owner in writing prior to commencement of the Work. Upon receipt of notice from the Contractor, the Owner may delay commencement of the Work and may obtain insurance that will protect the interests of the Owner in the Work. When the failure to provide coverage has been cured or resolved, the Contract Sum and Contract Time shall not be equitably adjusted. In the event the Contractor fails to procure coverage, the Contractor waives all rights against the Owner to the extent the loss to the Contractor (including Subcontractors and Sub-subcontractors) would have been covered by the insurance to have been procured by the Contractor. The cost of the insurance shall be charged to the Contractor by a Change Order. If the Contractor does not provide written notice, and the Owner is damaged by the failure or neglect of the Contractor to purchase or maintain the required insurance, the Contractor shall reimburse the Owner for all reasonable costs and damages attributable thereto.

**§ 11.1.5 Notice of Cancellation or Expiration of Contractor's Required Insurance.** Within three (3) business days of the date the Contractor becomes aware of an impending or actual cancellation or expiration of any insurance required by the Contract Documents, the Contractor shall provide notice to the Owner and all additional insureds of such impending or actual cancellation or expiration. Unless the lapse in coverage arises from an act or omission of the Owner: (1) the Owner, upon receipt of notice from the Contractor, shall have the right to stop the Work until the lapse in coverage has been cured by the procurement of replacement coverage by either the Owner or the Contractor; (2) the Contract Time and Contract Sum shall not be equitably adjusted; and (3) the Contractor waives all rights against the Owner to the extent any loss to the Contractor, Subcontractors, and Sub-subcontractors would have been covered by the insurance had it not expired or been cancelled. If the Owner purchases replacement coverage, the cost of the insurance shall be charged to the Contractor by an appropriate Change Order. The furnishing of notice by the Contractor shall not relieve the Contractor of any contractual obligation to provide any required coverage.

## **§ 11.2 Owner's Insurance**

**§ 11.2.1** The Owner shall purchase and maintain insurance of the types and limits of liability, containing the endorsements, and subject to the terms and conditions, as described in the Agreement or elsewhere in the Contract Documents. The Owner shall purchase and maintain the required insurance from an insurance company or insurance companies lawfully authorized to issue insurance in the jurisdiction where the Project is located.

### **§ 11.2.2 Reserved**

### **§ 11.2.3 Reserved**

## **§ 11.3 Waivers of Subrogation**

**§ 11.3.1** The Owner and Contractor waive all rights against (1) each other and any of their subcontractors, sub-subcontractors, agents, and employees, each of the other; (2) the Architect and Architect's consultants; and (3) Separate Contractors, if any, and any of their subcontractors, sub-subcontractors, agents, and employees, for damages caused by fire, or other causes of loss, to the extent those losses are covered by property insurance required by the Agreement or other property insurance applicable to the Project, except such rights as they have to proceeds of such insurance. The Owner or Contractor, as appropriate, shall require similar written waivers in favor of the individuals and entities identified above from the Architect, Architect's consultants, Separate Contractors, subcontractors, and sub-subcontractors. The policies of insurance purchased and maintained by each person or entity agreeing to waive claims pursuant to this section 11.3.1 shall not prohibit this waiver of subrogation. This waiver of subrogation shall be effective as to a person or entity (1) even though that person or entity would otherwise have a duty of indemnification, contractual or otherwise, (2) even though that person or entity did not pay the insurance premium directly or indirectly, or (3) whether or not the person or entity had an insurable interest in the damaged property.

**§ 11.3.2** If during the Project construction period the Owner insures properties, real or personal or both, at or adjacent to the site by property insurance under policies separate from those insuring the Project, or if after final payment property insurance is to be provided on the completed Project through a policy or policies other than those insuring the Project during the construction period, to the extent permissible by such policies, the Owner waives all rights in accordance with the terms of Section 11.3.1 for damages caused by fire or other causes of loss covered by this separate property insurance.

### **§ 11.3.3 Limitation on the Owner's Waiver of Subrogation**

South Carolina law prohibits the State from indemnifying a private party. Accordingly, and notwithstanding anything in the Agreement to the contrary, including but not limited to Sections 11.3.1, 11.3.2, and 11.4, the Owner cannot and

does not waive subrogation to the extent any losses are covered by insurance provided by the South Carolina Insurance Reserve Fund.

#### **§ 11.4 Loss of Use, Business Interruption, and Delay in Completion Insurance**

The Owner, at the Owner's option, may purchase and maintain insurance that will protect the Owner against loss of use of the Owner's property, or the inability to conduct normal operations, due to fire or other causes of loss. The Owner waives all rights of action against the Contractor and Architect for loss of use of the Owner's property, due to fire or other hazards however caused.

#### **§ 11.5 Adjustment and Settlement of Insured Loss**

**§ 11.5.1** A loss insured under the property insurance required by the Agreement shall be adjusted by the Contractors as fiduciary and made payable to the Contractor as fiduciary for the insureds, as their interests may appear, subject to requirements of any applicable mortgagee clause and of Section 11.5.2. The Contractor shall pay the Architect and Owner their just shares of insurance proceeds received by the Contractor, and by appropriate agreements the Architect and Owner shall make payments to their consultants and separate contractors in similar manner.

**§ 11.5.2** Prior to settlement of an insured loss, the Contractor shall notify the Owner of the terms of the proposed settlement as well as the proposed allocation of the insurance proceeds. The Owner shall have 14 days from receipt of notice to object to the proposed settlement or allocation of the proceeds. If the Owner does not object, the Contractor shall settle the loss and the Owner shall be bound by the settlement and allocation. Upon receipt, the Contractor shall deposit the insurance proceeds in a separate account and make the appropriate distributions. Thereafter, if no other agreement is made or the Owner does not terminate the Contract for convenience, the Owner and Contractor shall execute a Change Order for reconstruction of the damaged or destroyed Work in the amount allocated for that purpose. If the Owner timely objects to either the terms of the proposed settlement or the allocation of the proceeds, the Contractor may proceed to settle the insured loss, and any dispute between the Owner and Contractor arising out of the settlement or allocation of the proceeds shall be resolved pursuant to Article 15. Pending resolution of any dispute, the Owner may issue a Construction Change Directive for the reconstruction of the damaged or destroyed Work.

**§ 11.5.3** If required in writing by a party in interest, the Contractor as fiduciary shall, upon occurrence of an insured loss, give bond for proper performance of the Contractor's duties. The cost of required bonds shall be charged against proceeds received as fiduciary. The Contractor shall deposit in a separate account proceeds so received, which the Contractor shall distribute in accordance with such agreement as the parties in interest may reach. If after such loss no other special agreement is made and unless the Owner terminates the Contract for convenience, replacement of damaged property shall be performed by the Contractor.

### **ARTICLE 12 UNCOVERING AND CORRECTION OF WORK**

#### **§ 12.1 Uncovering of Work**

**§ 12.1.1** If a portion of the Work is covered contrary to the requirements specifically expressed in the Contract Documents, including inspections of work-in-progress required by all authorities having jurisdiction over the Project, it must, upon demand of the Architect or authority having jurisdiction, be uncovered for observation/inspection and be replaced at the Contractor's expense without change in the Contract Time.

**§ 12.1.2** If a portion of the Work has been covered that the Architect has not specifically requested to examine prior to its being covered, the Architect may request to see such Work and it shall be uncovered by the Contractor. If such Work is in accordance with the Contract Documents, the Contractor shall be entitled to an equitable adjustment to the Contract Sum and Contract Time as may be appropriate. If such Work is not in accordance with the Contract Documents, the costs of uncovering the Work, and the cost of correction, shall be at the Contractor's expense unless the condition was caused by the Owner or a Separate Contractor in which event the Owner shall be responsible for payment of such costs.

#### **§ 12.2 Correction of Work**

##### **§ 12.2.1 Before Substantial Completion**

The Contractor shall promptly correct Work rejected by the Architect or failing to conform to the requirements of the Contract Documents, discovered before Substantial Completion and whether or not fabricated, installed or completed. Costs of correcting such rejected Work, including additional testing and inspections, the cost of uncovering and replacement, and compensation for the Architect's services and expenses made necessary thereby, shall be at the Contractor's expense.



- .1 If the Contractor, a Subcontractor, or anyone for whom either is responsible, uses or damages any portion of the Work, including, without limitation, mechanical, electrical, plumbing, and other building systems, machinery, equipment, or other mechanical device, the Contractor shall cause such item to be restored to "like new" condition at no expense to the Owner.

### § 12.2.2 After Substantial Completion

§ 12.2.2.1 In addition to the Contractor's obligations under Section 3.5, if, within one year after the date of Substantial Completion of the Work or designated portion thereof or after the date for commencement of warranties established under Section 9.9.1, or by terms of any applicable special warranty required by the Contract Documents, any of the Work is found to be not in accordance with the requirements of the Contract Documents, the Contractor shall correct it promptly after receipt of notice from the Owner to do so, unless the Owner has previously given the Contractor a written acceptance of such condition. The Owner shall give such notice promptly after discovery of the condition. During the one-year period for correction of Work, if the Owner fails to notify the Contractor and give the Contractor an opportunity to make the correction, the Owner waives the rights to require correction by the Contractor. If the Contractor fails to correct nonconforming Work within a reasonable time during that period after receipt of notice from the Owner or Architect, the Owner may correct it in accordance with Section 2.5.

§ 12.2.2.2 The one-year period for correction of Work shall be extended with respect to portions of Work first performed after Substantial Completion by the period of time between Substantial Completion and the actual completion of that portion of the Work.

§ 12.2.2.3 The one-year period for correction of Work shall not be extended by corrective Work performed by the Contractor pursuant to this Section 12.2 unless otherwise provided in the Contract Documents.

§ 12.2.3 The Contractor shall remove from the site portions of the Work that are not in accordance with the requirements of the Contract Documents and are neither corrected by the Contractor nor accepted by the Owner.

§ 12.2.4 The Contractor shall bear the cost of correcting destroyed or damaged construction of the Owner or Separate Contractors, whether completed or partially completed, caused by the Contractor's correction or removal of Work that is not in accordance with the requirements of the Contract Documents.

§ 12.2.5 Nothing contained in this Section 12.2 shall be construed to establish a period of limitation with respect to other obligations the Contractor has under the Contract Documents. Establishment of the one-year period for correction of Work as described in Section 12.2.2 relates only to the specific obligation of the Contractor to correct the Work, and has no relationship to the time within which the obligation to comply with the Contract Documents may be sought to be enforced, nor to the time within which proceedings may be commenced to establish the Contractor's liability with respect to the Contractor's obligations other than specifically to correct the Work.

### § 12.3 Acceptance of Nonconforming Work

If the Owner prefers to accept Work that is not in accordance with the requirements of the Contract Documents, the Owner may do so instead of requiring its removal and correction, in which case the Contract Sum will be reduced as appropriate and equitable. Such adjustment shall be effected whether or not final payment has been made.

## ARTICLE 13 MISCELLANEOUS PROVISIONS

### § 13.1 Governing Law

§ 13.1.1 The Contract, any dispute, claim, or controversy relating to the Contract, and all the rights and obligations of the parties shall, in all respects, be interpreted, construed, enforced and governed by and under the laws of the State of South Carolina, except its choice of law rules.

§ 13.1.2 This Contract is formed pursuant to and governed by the South Carolina Consolidated Procurement Code and is deemed to incorporate all applicable provisions thereof and the ensuing regulations.

### § 13.2 Successors and Assigns

The Owner and Contractor respectively bind themselves, their partners, successors, assigns, and legal representatives to covenants, agreements, and obligations contained in the Contract Documents. Neither party to the Contract shall assign the Contract as a whole, or in part, without written consent of the other and then only in accordance with and as permitted by Regulation 19-445.2180 of the South Carolina Code of Regulations, as amended. If either party attempts

to make an assignment without such consent, that party shall nevertheless remain legally responsible for all obligations under the Contract.

### § 13.3 Rights and Remedies

§ 13.3.1 Unless expressly provided otherwise, duties and obligations imposed by the Contract Documents and rights and remedies available thereunder shall be in addition to and not a limitation of duties, obligations, rights, and remedies otherwise imposed or available by law.

§ 13.3.2 No action or failure to act by the Owner, Architect, or Contractor shall constitute a waiver of a right or duty afforded them under the Contract, nor shall such action or failure to act constitute approval of or acquiescence in a breach thereunder, except as may be specifically agreed upon in writing.

§ 13.3.3 Notwithstanding Section 9.10.4, the rights and obligations which, by their nature, would continue beyond the termination, cancellation, rejection, or expiration of this contract shall survive such termination, cancellation, rejection, or expiration, including, but not limited to, the rights and obligations created by the following clauses:

- 1.5 Ownership and Use of Drawings, Specifications and Other Instruments of Service;
- 3.5 Warranty
- 3.17 Royalties, Patents and Copyrights
- 3.18 Indemnification
- 7.5 Pricing Data and Audit
- A.3.2.2 Contractor's Liability Insurance (A101, Exhibit A)
- A.3.5 Performance and Payment Bond (A101, Exhibit A)
- 15.1.7 Claims for Listed Damages
- 15.1.8 Waiver of Claims Against the Architect
- 15.6 Dispute Resolution
- 15.6.5 Service of Process

### § 13.4 Tests and Inspections

§ 13.4.1 Tests, inspections, and approvals of portions of the Work shall be made as required by the Contract Documents and by applicable laws, statutes, ordinances, codes, rules, and regulations or lawful orders of public authorities. Unless otherwise provided, the Contractor shall make arrangements for such tests, inspections, and approvals with an independent testing laboratory or entity acceptable to the Owner, or with the appropriate public authority, and shall bear all related costs of tests, inspections, and approvals. The Contractor shall give the Owner and Architect timely notice of when and where tests and inspections are to be made so that they may be present for such procedures. The Owner shall bear costs of tests, inspections, or approvals that do not become requirements until after bids are received or negotiations concluded. The Owner shall directly arrange and pay for tests, inspections, or approvals where building codes or applicable laws or regulations so require.

- .1 Inspection, Special Inspections, and testing requirements, if any, as required by the ICC series of Building Codes shall be purchased by the Owner.
- .2 Contractor shall schedule and request inspections in an orderly and efficient manner and shall notify the Owner whenever the Contractor schedules an inspection. Contractor shall be responsible for the cost of inspections scheduled and conducted without the Owner's knowledge and for any increase in the cost of inspections resulting from the inefficient scheduling of inspections.

§ 13.4.2 If the Architect, Owner, or public authorities having jurisdiction determine that portions of the Work require additional testing, inspection, or approval not included under Section 13.4.1, the Architect will, upon written authorization from the Owner, instruct the Contractor to make arrangements for such additional testing, inspection, or approval, by an entity acceptable to the Owner, and the Contractor shall give timely notice to the Owner and Architect of when and where tests and inspections are to be made so that the Architect may be present for such procedures. Such costs, except as provided in Section 13.4.3, shall be at the Owner's expense.

§ 13.4.3 If procedures for testing, inspection, or approval under Sections 13.4.1 and 13.4.2 reveal failure of the portions of the Work to comply with requirements established by the Contract Documents, all costs made necessary by such failure, including those of repeated procedures and compensation for the Architect's services and expenses, shall be at the Contractor's expense and shall be deducted from future Applications of Payment.

§ 13.4.4 Required certificates of testing, inspection, or approval shall, unless otherwise required by the Contract Documents, be secured by the Contractor and promptly delivered to the Architect.

§ 13.4.5 If the Architect is to observe tests, inspections, or approvals required by the Contract Documents, the Architect will do so promptly and, where practicable, at the normal place of testing.

§ 13.4.6 Tests or inspections conducted pursuant to the Contract Documents shall be made promptly to avoid unreasonable delay in the Work.

### § 13.5 Interest

Payments due to the Contractor and unpaid under the Contract Documents shall bear interest only if and to the extent allowed by S.C. Code Ann. §§ 29-6-10 through 29-6-60. Amounts due to the Owner shall bear interest at the rate of one percent a month or a pro rata fraction thereof on the unpaid balance as may be due.

### § 13.6 Procurement of Materials by Owner

The Contractor accepts assignment of all purchase orders and other agreements for procurement of materials and equipment by the Owner that are identified as part of the Contract Documents. The Contractor shall, upon delivery, be responsible for the storage, protection, proper installation, and preservation of such Owner purchased items, if any, as if the Contractor were the original purchaser. The Contract Sum includes, without limitation, all costs and expenses in connection with delivery, storage, insurance, installation, and testing of items covered in any assigned purchase orders or agreements. Unless the Contract Documents specifically provide otherwise, all Contractor warranty of workmanship and correction of the Work obligations under the Contract Documents shall apply to the Contractor's installation of and modifications to any Owner purchased items.

### § 13.7 Interpretation of Building Codes

As required by S.C. Code Ann. § 10-1-180, OSE shall determine the enforcement and interpretation of all building codes and referenced standards on state buildings. The Contractor shall refer any questions, comments, or directives from local officials to the Owner and OSE for resolution.

### § 13.8 Minority Business Enterprises

Contractor shall notify Owner of each Minority Business Enterprise (MBE) providing labor, materials, equipment, or supplies to the Project under a contract with the Contractor. Contractor's notification shall be via the first monthly status report submitted to the Owner after execution of the contract with the MBE. For each such MBE, the Contractor shall provide the MBE's name, address, and telephone number, the nature of the work to be performed or materials or equipment to be supplied by the MBE, whether the MBE is certified by the South Carolina Office of Small and Minority Business Assistance, and the value of the contract.

### § 13.9 Illegal Immigration

Contractor certifies and agrees that it will comply with the applicable requirements of Title 8, Chapter 14 of the South Carolina Code of Laws and agrees to provide to the State upon request any documentation required to establish either: (a) that Title 8, Chapter 14 is inapplicable both to Contractor and its subcontractors or sub-subcontractors; or (b) that Contractor and its subcontractors or sub-subcontractors are in compliance with Title 8, Chapter 14. Pursuant to Section 8-14-60, "A person who knowingly makes or files any false, fictitious, or fraudulent document, statement, or report pursuant to this chapter is guilty of a felony and, upon conviction, must be fined within the discretion of the court or imprisoned for not more than five years, or both." Contractor agrees to include in any contracts with its subcontractor's language requiring its subcontractors to (a) comply with the applicable requirements of Title 8, Chapter 14, and (b) include in their contracts with the sub-subcontractor's language requiring the sub-subcontractors to comply with the applicable requirements of Title 8, Chapter 14. (An overview is available at [www.procurement.sc.gov](http://www.procurement.sc.gov))

### § 13.10 Drug-Free Workplace

The Contractor must comply with the Drug-Free Workplace Act, S.C. Code Ann. §§ 44-107-10, et seq. The Contractor certifies to the Owner that Contractor will provide a Drug-Free Workplace, as defined by S.C. Code Ann. § 44-107-20(1).

### § 13.11 False Claims

According to S.C. Code Ann. § 16-13-240, "a person who by false pretense or representation obtains the signature of a person to a written instrument or obtains from another person any chattel, money, valuable security, or other property, real or personal, with intent to cheat and defraud a person of that property is guilty" of a crime.



### § 13.12 Prohibited Acts

It is unlawful for a person charged with disbursements of state funds appropriated by the General Assembly to exceed the amounts and purposes stated in the appropriations. (§ 11-9-20) It is unlawful for an authorized public officer to enter into a contract for a purpose in which the sum is in excess of the amount appropriated for that purpose. It is unlawful for an authorized public officer to divert or appropriate the funds arising from any tax levied and collected for any one fiscal year to the payment of an indebtedness contracted or incurred for a previous year. (§ 11-1-40)

### § 13.13 Open Trade (Jun 2015)

During the contract term, including any renewals or extensions, Contractor will not engage in the boycott of a person or an entity based in or doing business with a jurisdiction with whom South Carolina can enjoy open trade, as defined in S.C. Code Ann. § 11-35-5300.

## ARTICLE 14 TERMINATION OR SUSPENSION OF THE CONTRACT

### § 14.1 Termination by the Contractor

§ 14.1.1 The Contractor may terminate the Contract if the Work is stopped for a period of 45 consecutive days through no act or fault of the Contractor, a Subcontractor, a Sub-subcontractor, their agents or employees, or any other persons or entities performing portions of the Work, for any of the following reasons:

- .1 Issuance of an order of a court or other public authority having jurisdiction that requires substantially all Work to be stopped; or
- .2 An act of government, such as a declaration of national emergency, that requires all Work to be stopped;
- .3 Because the Architect has not issued a Certificate for Payment and has not notified the Contractor of the reason for withholding certification as provided in Section 9.4.1, or because the Owner has not made payment on a Certificate for Payment within the time stated in the Contract Documents and the Contractor has stopped work in accordance with Section 9.7.

§ 14.1.2 The Contractor may terminate the Contract if, through no act or fault of the Contractor, a Subcontractor, a Sub-subcontractor, their agents or employees, or any other persons or entities performing portions of the Work, repeated suspensions, delays, or interruptions of the entire Work by the Owner as described in Section 14.3, constitute in the aggregate more than 100 percent of the total number of days scheduled for completion, or 120 days in any 365-day period, whichever is less.

§ 14.1.3 If one of the reasons described in Section 14.1.1 or 14.1.2 exists, the Contractor may, upon seven days' notice to the Owner and Architect, terminate the Contract and recover from the Owner payment for Work executed, as well as reasonable overhead and profit, and costs incurred by reason of such termination.

§ 14.1.4 If the Work is stopped for a period of 60 consecutive days through no act or fault of the Contractor, a Subcontractor, a Sub-subcontractor, or their agents or employees or any other persons or entities performing portions of the Work because the Owner has persistently failed to fulfill the Owner's obligations under the Contract Documents with respect to matters important to the progress of the Work, the Contractor may, upon seven additional days' notice to the Owner and the Architect, terminate the Contract and recover from the Owner as provided in Section 14.1.3.

### § 14.2 Termination by the Owner for Cause

§ 14.2.1 The Owner may terminate the Contract if the Contractor

- .1 repeatedly refuses or fails to supply enough properly skilled workers or proper materials, or otherwise fails to prosecute the Work, or any separable part of the Work, with the diligence, resources and skill that will ensure its completion within the time specified in the Contract Documents, including any authorized adjustments;
- .2 fails to make payment to Subcontractors or suppliers in accordance with the Contract Documents and the respective agreements between the Contractor and the Subcontractors or suppliers;
- .3 repeatedly disregards applicable laws, statutes, ordinances, codes, rules and regulations, or lawful orders of a public authority; or
- .4 otherwise is guilty of substantial breach of a provision of the Contract Documents.

§ 14.2.2 When any of the reasons described in Section 14.2.1 exist, the Owner may, without prejudice to any other rights or remedies of the Owner and after giving the Contractor and the Contractor's surety, if any, seven days' notice, terminate employment of the Contractor and may, subject to any prior rights of the surety:

Init.

- .1 Exclude the Contractor from the site and take possession of all materials, equipment, tools, and construction equipment and machinery thereon owned by the Contractor;
- .2 Accept assignment of subcontracts pursuant to Section 5.4; and
- .3 Finish the Work by whatever reasonable method the Owner may deem expedient. Upon written request of the Contractor, the Owner shall furnish to the Contractor a detailed accounting of the costs incurred by the Owner in finishing the Work.

§ 14.2.3 When the Owner terminates the Contract for one of the reasons stated in Section 14.2.1, the Contractor shall not be entitled to receive further payment until the Work is finished.

§ 14.2.4 If the unpaid balance of the Contract Sum exceeds costs of finishing the Work, including compensation for the Architect's services and expenses made necessary thereby, and other damages incurred by the Owner and not expressly waived, such excess shall be paid to the Contractor. If such costs and damages exceed the unpaid balance, the Contractor shall pay the difference to the Owner. The amount to be paid to the Contractor or Owner, as the case may be, shall be certified by the Architect, upon application, and this obligation for payment shall survive termination of the Contract.

§ 14.2.5 If, after termination for cause, it is determined that the Owner lacked justification to terminate under Section 14.2.1, or that the Contractor's default was excusable, or that the termination for cause was affected by any other error, then Owner and Contractor agree that the termination shall be conclusively deemed to be one for the convenience of the Owner, and the rights and obligations of the parties shall be the same as if the termination had been issued for in Section 14.4.

#### § 14.3 Suspension by the Owner for Convenience

§ 14.3.1 The Owner may, without cause, order the Contractor in writing to suspend, delay or interrupt the Work, in whole or in part for such period of time as the Owner may determine.

§ 14.3.2 The Contract Sum and Contract Time shall be adjusted for increases in the cost and time caused by suspension, delay, or interruption under Section 14.3.1. No adjustment shall be made to the extent

- .1 that performance is, was, or would have been, so suspended, delayed, or interrupted, by another cause for which the Contractor is responsible; or
- .2 that an equitable adjustment is made or denied under another provision of the Contract.

#### § 14.4 Termination by the Owner for Convenience

§ 14.4.1 The Owner may, at any time, terminate the Contract in whole or in part for the Owner's convenience and without cause. The Owner shall give notice of the termination to the Contractor specifying the part of the Contract terminated and when termination becomes effective.

§ 14.4.2 Upon receipt of notice from the Owner of such termination for the Owner's convenience, the Contractor shall

- .1 cease operations as directed by the Owner in the notice;
- .2 take actions necessary, or that the Owner may direct, for the protection and preservation of the Work;
- .3 except for Work directed to be performed prior to the effective date of termination stated in the notice, terminate all existing subcontracts and purchase orders and enter into no further subcontracts and purchase orders; and
- .4 complete the performance of the Work not terminated, if any.

§ 14.4.3 In case of such termination for the Owner's convenience, the Owner shall pay the Contractor for Work properly executed; costs incurred by reason of the termination, including costs attributable to termination of Subcontracts; and any other adjustments otherwise set forth in the Agreement.

§ 14.4.4 Contractor's failure to include an appropriate termination for convenience clause in any subcontract shall not (i) affect the Owner's right to require the termination of a subcontract, or (ii) increase the obligation of the Owner beyond what it would have been if the subcontract had contained an appropriate clause.

§ 14.4.5 Upon written consent of the Contractor, the Owner may reinstate the terminated portion of this Contract in whole or in part by amending the notice of termination if it has been determined that:

- .1 the termination was due to withdrawal of funding by the General Assembly, Governor, or State Fiscal Accountability Authority or the need to divert project funds to respond to an emergency as defined by Regulation 19-445.2110(B) of the South Carolina Code of Regulations, as amended;

- .2 funding for the reinstated portion of the Work has been restored;
- .3 circumstances clearly indicate a requirement for the terminated Work; and
- .4 reinstatement of the terminated work is advantageous to the Owner.

## ARTICLE 15 CLAIMS AND DISPUTES

### § 15.1 Claims

#### § 15.1.1 Definition

A Claim is a demand or assertion by one of the parties seeking, as a matter of right, payment of money, a change in the Contract Time, or other relief with respect to the terms of the Contract. The term "Claim" also includes other disputes and matters in question between the Owner and Contractor arising out of or relating to the Contract. A voucher, invoice, payment application or other routine request for payment that is not in dispute when submitted is not a Claim under this definition. The responsibility to substantiate Claims shall rest with the party making the Claim. This Section 15.1.1 does not require the Owner to file a Claim in order to impose liquidated damages in accordance with the Contract Documents.

#### § 15.1.2 Reserved

#### § 15.1.3 Notice of Claims

§ 15.1.3.1 Claims by either the Owner or Contractor, where the condition giving rise to the Claim is first discovered prior to expiration of the period for correction of the Work set forth in Section 12.2.2, shall be initiated by notice to the other party and to the Architect. Such notice shall include sufficient information to advise the Architect and other party of the circumstances giving rise to the Claim, the specific contractual adjustment or relief requested and the basis of such request. Claims by either party under this Section 15.1.3.1 shall be initiated within 21 days after occurrence of the event giving rise to such Claim or within 21 days after the claimant first recognizes the condition giving rise to the Claim, whichever is later except as stated for adverse weather days in Section 15.1.6.2. By failing to give written notice of a Claim within the time required by this Section, a party expressly waives its Claim.

§ 15.1.3.2 Claims by either the Owner or Contractor, where the condition giving rise to the Claim is first discovered after expiration of the period for correction of the Work set forth in Section 12.2.2, shall be initiated by notice to the other party. In such event, no decision by the Architect is required.

#### § 15.1.4 Continuing Contract Performance

§ 15.1.4.1 Pending final resolution of a Claim, including any administrative review allowed under Section 15.6, except as otherwise agreed in writing or as provided in Section 9.7 and Article 14, the Contractor shall proceed diligently with performance of the Contract and the Owner shall continue to make payments in accordance with the Contract Documents.

§ 15.1.4.2 The Contract Sum and Contract Time shall be adjusted in accordance with the Architect's decision, subject to the right of either party to proceed in accordance with this Article 15. The Architect will issue Certificates for Payment in accordance with the decision of the Initial Decision Maker.

#### § 15.1.5 Claims for Additional Cost

If the Contractor wishes to make a Claim for an increase in the Contract Sum, notice as provided in Section 15.1.3 shall be given before proceeding to execute the portion of the Work that is the subject of the Claim. Prior notice is not required for Claims relating to an emergency endangering life or property arising under Section 10.4.

#### § 15.1.6 Claims for Additional Time

§ 15.1.6.1 If the Contractor wishes to make a Claim for an increase in the Contract Time, notice as provided in Section 15.1.3 shall be given. The Contractor's Claim shall include an estimate of cost and of probable effect of delay on progress of the Work. In the case of a continuing delay, only one Claim is necessary. Claims for an increase in the Contract Time shall be based on one additional calendar day for each full calendar day that the Contractor is prevented from working.

§ 15.1.6.2 If adverse weather conditions are the basis for a Claim for additional time, such Claim shall be documented by data substantiating that weather conditions were abnormal for the period of time, could not have been reasonably anticipated, and had an adverse effect on the scheduled construction.

- .1 Claims for adverse weather shall be based on actual weather conditions at the job site or other place of performance of the Work, as documented in the Contractor's job site log.

Init.

- .2 For the purpose of this Contract, a total of five (5) days per calendar month (non-cumulative) shall be anticipated as "adverse weather" at the job site, and such time will not be considered justification for an extension of time. If, in any month, adverse weather develops beyond the five (5) days, the Contractor shall be allowed to claim additional days to compensate for the excess weather delays only to the extent of the impact on the approved construction schedule and days the Contractor was already scheduled to work. The remedy for this condition is for an extension of time only and is exclusive of all other rights and remedies available under the Contract Documents or imposed or available by law.
- .3 The Contractor shall submit monthly with their pay application all Claims for adverse weather conditions that occurred during the previous month. The Architect shall review each monthly submittal in accordance with Section 15.5 and inform the Contractor and the Owner promptly of its evaluation. Approved days shall be included in the next Change Order issued by the Architect. Adverse weather conditions not claimed within the time limits of this Subparagraph shall be considered to be waived by the Contractor. Claims will not be allowed for adverse weather days that occur after the scheduled (original or adjusted) date of Substantial Completion.

§ 15.1.6.3 Claims for increase in the Contract Time shall set forth in detail the circumstances that form the basis for the Claim, the date upon which each cause of delay began to affect the progress of the Work, the date upon which each cause of delay ceased to affect the progress of the work, and the number of days increase in the Contract Time claimed as a consequence of each such cause of delay. The Contractor shall provide such supporting documentation as the Owner may require including, where appropriate, a revised construction schedule indicating all the activities affected by the circumstances forming the basis of the Claim.

§ 15.1.6.4 The Contractor shall not be entitled to a separate increase in the Contract Time for each one of the number of causes of delay which may have concurrent or interrelated effects on the progress of the Work, or for concurrent delays due to the fault of the Contractor.

#### § 15.1.7 Claims for Listed Damages

Notwithstanding any other provision of the Contract Documents, including Section 1.2.1, but subject to a duty of good faith and fair dealing, the Contractor and Owner waive Claims against each other for listed damages arising out of or relating to this Contract.

§ 15.1.7.1 For the Owner, listed damages are (i) lost revenue and profit, (ii) losses resulting from injury to business or reputation, (iii) additional or escalated overhead and administration expenses, (iv) additional financing costs, (v) costs suffered by a third party unable to commence work, (vi) attorney's fees, (vii) any interest, except to the extent allowed by Section 13.5 (Interest), (viii) lost revenue and profit for lost use of the property, (ix) costs resulting from lost productivity or efficiency.

§ 15.1.7.2 For the Contractor, listed damages are (i) lost revenue and profit, (ii) losses resulting from injury to business or reputation, (iii) additional or escalated overhead and administration expenses, (iv) additional financing costs, (v) attorney's fees, (vi) any interest, except to the extent allowed by Section 13.5 (Interest); (vii) unamortized equipment costs; and, (viii) losses incurred by subcontractors for the types of damages the Contractor has waived as against the Owner. Without limitation, this mutual waiver is applicable to all damages due to either party's termination in accordance with Article 14.

§ 15.1.7.3 Nothing contained in this Section shall be deemed to preclude an award of liquidated damages, when applicable, in accordance with the requirements of the Contract Documents. This mutual waiver is not applicable to amounts due or obligations under Section 3.18 (Indemnification).

#### § 15.1.8 Waiver of Claims Against the Architect

Notwithstanding any other provision of the Contract Documents, including Section 1.2.1, but subject to a duty of good faith and fair dealing, the Contractor waives all claims against the Architect and any other design professionals who provide design and/or project management services to the Owner, either directly or as independent contractors or subcontractors to the Architect, for listed damages arising out of or relating to this Contract. The listed damages are (i) lost revenue and profit, (ii) losses resulting from injury to business or reputation, (iii) additional or escalated overhead and administration expenses, (iv) additional financing costs, (v) attorney's fees, (vi) any interest; (vii) unamortized equipment costs; and, (viii) losses incurred by subcontractors for the types of damages the Contractor has waived as against the Owner. This mutual waiver is not applicable to amounts due or obligations under Section 3.18 (Indemnification).

§ 15.2 Reserved

§ 15.3 Reserved

§ 15.4 Reserved

**§ 15.5 Claim and Disputes - Duty of Cooperation, Notice, and Architects Initial Decision**

§ 15.5.1 Contractor and Owner are fully committed to working with each other throughout the Project to avoid or minimize Claims. To further this goal, Contractor and Owner agree to communicate regularly with each other and the Architect at all times notifying one another as soon as reasonably possible of any issue that if not addressed may cause loss, delay, and/or disruption of the Work. If Claims do arise, Contractor and Owner each commit to resolving such Claims in an amicable, professional, and expeditious manner to avoid unnecessary losses, delays, and disruptions to the Work.

§ 15.5.2 Claims shall first be referred to the Architect for initial decision. An initial decision shall be required as a condition precedent to resolution pursuant to Section 15.6 of any Claim arising prior to the date of final payment, unless 30 days have passed after the Claim has been referred to the Architect with no decision having been rendered, or after all the Architect's requests for additional supporting data have been answered, whichever is later. The Architect will not address Claims between the Contractor and persons or entities other than the Owner.

§ 15.5.3 The Architect will review Claims and within ten days of the receipt of a Claim (1) request additional supporting data from the claimant or a response with supporting data from the other party or (2) render an initial decision in accordance with Section 15.5.5.

§ 15.5.4 If the Architect requests a party to provide a response to a Claim or to furnish additional supporting data, such party shall respond, within ten days after receipt of such request, and shall either (1) provide a response on the requested supporting data, (2) advise the Architect when the response or supporting data will be furnished or (3) advise the Architect that all supporting data has already been provided. Upon receipt of the response or supporting data, the Architect will render an initial decision in accordance with Section 15.5.5.

§ 15.5.5 The Architect will render an initial decision in writing; (1) stating the reasons therefor; and (2) notifying the parties of any change in the Contract Sum or Contract Time or both. The Architect will deliver the initial decision to the parties within two weeks of receipt of any response or supporting data requested pursuant to Section 16.4 or within such longer period as may be mutually agreeable to the parties. If the parties accept the initial decision, the Architect shall prepare a Change Order with appropriate supporting documentation for the review and approval of the parties and the Office of State Engineer. If either the Contractor, Owner, or both, disagree with the initial decision, the Contractor and Owner shall proceed with dispute resolution in accordance with the provisions of Section 15.6.

§ 15.5.6 In the event of a Claim against the Contractor, the Owner may, but is not obligated to, notify the surety, if any, of the nature and amount of the Claim. If the Claim relates to a possibility of a Contractor's default, the Owner may, but is not obligated to, notify the surety and request the surety's assistance in resolving the controversy.

**§ 15.6 Dispute Resolution**

§ 15.6.1 If a Claim is not resolved pursuant to Section 15.5 to the satisfaction of either party, both parties shall attempt to resolve the dispute at the field level through discussions between Contractor's Representative and Owner's Representative. If a dispute cannot be resolved through Contractor's Representative and Owner's Representative, then the Contractor's Senior Representative and the Owner's Senior Representative, upon the request of either party, shall meet as soon as conveniently possible, but in no case later than twenty-one (21) days after such a request is made, to attempt to resolve such dispute. Prior to any meetings between the Senior Representatives, the parties will exchange relevant information that will assist the parties in resolving their dispute. The meetings required by this Section are a condition precedent to resolution pursuant to Section 15.6.2.

§ 15.6.2 If after meeting in accordance with the provisions of Section 15.6.1, the Senior Representatives determine that the dispute cannot be resolved on terms satisfactory to both the Contractor and the Owner, then either party may submit the dispute by written request to South Carolina's Chief Procurement Officer for Construction (CPOC). Except as otherwise provided in Article 15, all Claims, or controversies relating to the Contract shall be resolved exclusively by the appropriate Chief Procurement Officer in accordance with Title 11, Chapter 35, Article 17 of the

Init.



South Carolina Code of Laws, or in the absence of jurisdiction, only in the Court of Common Pleas for, or in the absence of jurisdiction a federal court located in, Richland County, State of South Carolina. Contractor agrees that any act by the State regarding the Contract is not a waiver of either the State's sovereign immunity or the State's immunity under the Eleventh Amendment of the United States Constitution.

§ 15.6.3 If any party seeks resolution to a dispute pursuant to Section 15.6.2, the parties shall participate in non-binding mediation to resolve the Claim. If the Claim is governed by Title 11, Chapter 35, Article 17 of the South Carolina Code of Laws as amended and the amount in controversy is \$100,000.00 or less, the CPOC shall appoint a mediator, otherwise, the mediation shall be conducted by an impartial mediator selected by mutual agreement of the parties, or if the parties cannot so agree, a mediator designated by the American Arbitration Association ("AAA") pursuant to its Construction Industry Mediation Rules. The mediation will be governed by and conducted pursuant to a mediation agreement negotiated by the parties or, if the parties cannot so agree, by procedures established by the mediator.

§ 15.6.4 Without relieving any party from the other requirements of Sections 15.5 and 15.6, either party may initiate proceedings in the appropriate forum prior to initiating or completing the procedures required by Sections 15.5 and 15.6 if such action is necessary to preserve a claim by avoiding the application of any applicable statutory period of limitation or repose.

#### § 15.6.5 Service of Process

Contractor consents that any papers, notices, or process necessary or proper for the initiation or continuation of any Claims, or controversies relating to the Contract; for any court action in connection therewith; or for the entry of judgment on any award made, may be served on Contractor by certified mail (return receipt requested) addressed to Contractor at the address provided for the Contractor's Senior Representative or by personal service or by any other manner that is permitted by law, in or outside South Carolina. Notice by certified mail is deemed duly given upon deposit in the United States mail.

### ARTICLE 16 PROJECT-SPECIFIC REQUIREMENTS AND INFORMATION

Attachment "A"

for

AIA A201-2017 General Conditions of the Contract for Construction – South Carolina Division of Procurement Services, Office of State Engineer Version

1. Contractor shall add the following wording to their insurance policy per General Conditions of the Contract for Construction – South Carolina Division of Procurement Services, Office of State Engineer Version of the A201-2017, Article 11 – Insurance and Bonds, page 35 of 46 that the Agency shall be named as an additional insured. The Agency shall be named and noted on the insurance form as:

*"Coastal Carolina University, including its current and former trustees, officers, directors, employees, volunteer workers, agents, assigns and students are additional insured in respect to the General Liability Policy."*

2. The contractor, subcontractors and their employees performing work for Coastal Carolina University are required to comply with Title VII of the Civil Rights Act of 1964 and the Title IX Education Amendments of 1972, and subsequent amendments.
3. The use of all forms of tobacco and smoke related products (includes but not limited to, cigarettes, cigars, pipes, chewing tobacco, snuff, water pipes (hookahs), bidis, kreteks, smokeless tobacco, electronic cigarettes, and other devices allowing the ingestion, combustion, inhalation or other use of tobacco or other substances) is prohibited in or on all University property per Policy Number PRES-110 Tobacco-Free Campus created August 2008 and revised and approved December 2019.



# SE-355 PERFORMANCE BOND

**KNOW ALL MEN BY THESE PRESENTS**, that *(Insert full name or legal title and address of Contractor)*

Name: \_\_\_\_\_  
Address: \_\_\_\_\_  
\_\_\_\_\_

hereinafter referred to as "Contractor", and *(Insert full name and address of principal place of business of Surety)*

Name: \_\_\_\_\_  
Address: \_\_\_\_\_  
\_\_\_\_\_

hereinafter called the "surety", are jointly and severally held and firmly bound unto *(Insert full name and address of Agency)*

Name: Coastal Carolina University  
Address: P.O. Box 261954  
Conway, SC 29528-6054

hereinafter referred to as "Agency", or its successors or assigns, the sum of \_\_\_\_\_ (\$ \_\_\_\_\_), being the sum of the Bond to which payment to be well and truly made, the Contractor and Surety bind themselves, their heirs, executors, administrators, successors and assigns, jointly and severally, firmly by these presents.

**WHEREAS**, Contractor has by written agreement dated \_\_\_\_\_ entered into a contract with Agency to construct

State Project Name: Ingle Hall Flooring 2024  
State Project Number: H17-N150-CB  
Brief Description of Awarded Work: Demo, prepare, and replace all flooring in 16 2nd and 3rd floor 4-bedroom suites including 202, 203, 220, 221, 246, 247, 264, 265, 302, 303, 320, 321, 346, 347, 364, and 365 as well as all flooring in 128 2nd and 3rd floor bedrooms (restroom flooring is not to be replaced). Also demo, prepare, and replace flooring in lobby with specified porcelain tile.

in accordance with Drawings and Specifications prepared by *(Insert full name and address of AE)*

Name: Coastal Carolina University  
Address: P.O. Box 261954  
Conway, SC 29528-6054

which agreement is by reference made a part hereof, and is hereinafter referred to as the Contract.

**IN WITNESS WHEREOF**, Surety and Contractor, intending to be legally bound hereby, subject to the terms stated herein, do each cause this Performance Bond to be duly executed on its behalf by its authorized officer, agent or representative.

**DATED this** \_\_\_\_\_ **day of** \_\_\_\_\_, **2** \_\_\_\_\_  
*(shall be no earlier than Date of Contract)*

**BOND NUMBER** \_\_\_\_\_

**CONTRACTOR**

**By:** \_\_\_\_\_  
(Seal)

**Print Name:** \_\_\_\_\_

**Print Title:** \_\_\_\_\_

**Witness:** \_\_\_\_\_

**SURETY**

**By:** \_\_\_\_\_  
(Seal)

**Print Name:** \_\_\_\_\_

**Print Title:** \_\_\_\_\_  
*(Attach Power of Attorney)*

**Witness:** \_\_\_\_\_

*(Additional Signatures, if any, appear on attached page)*

**SE-355****PERFORMANCE BOND****NOW, THEREFORE, THE CONDITION OF THIS OBLIGATION IS SUCH THAT:**

1. The Contractor and the Surety, jointly and severally, bind themselves, their heirs, executors, administrators, successors and assigns to the Agency for the full and faithful performance of the contract, which is incorporated herein by reference.
2. If the Contractor performs the contract, the Surety and the Contractor have no obligation under this Bond, except to participate in conferences as provided in paragraph 3.1.
3. The Surety's obligation under this Bond shall arise after:
  - 3.1 The Agency has notified the Contractor and the Surety at the address described in paragraph 10 below, that the Agency is considering declaring a Contractor Default and has requested and attempted to arrange a conference with the Contractor and the Surety to be held not later than 15 days after receipt of such notice to discuss methods of performing the Contract. If the Agency, the Contractor and the Surety agree, the Contractor shall be allowed a reasonable time to perform the Contract, but such an agreement shall not waive the Agency's right, if any, subsequently to declare a Contractor Default; or
  - 3.2 The Agency has declared a Contractor Default and formally terminated the Contractor's right to complete the Contract.
4. The Surety shall, within 15 days after receipt of notice of the Agency's declaration of a Contractor Default, and at the Surety's sole expense, take one of the following actions:
  - 4.1 Arrange for the Contractor, with consent of the Agency, to perform and complete the Contract; or
  - 4.2 Undertake to perform and complete the Contract itself, through its agents or through independent contractors; or
  - 4.3 Obtain bids or negotiated proposals from qualified contractors acceptable to the Agency for a contract for performance and completion of the Contract, arrange for a contract to be prepared for execution by the Agency and the contractor selected with the Agency's concurrence, to be secured with performance and payment bonds executed by a qualified surety equivalent to the Bonds issued on the Contract, and pay to the Agency the amount of damages as described in paragraph 7 in excess of the Balance of the Contract Sum incurred by the Agency resulting from the Contractor Default; or
  - 4.4 Waive its right to perform and complete, arrange for completion, or obtain a new contractor, and:
    - 4.4.1 After investigation, determine the amount for which it may be liable to the Agency and, within 60 days of waiving its rights under this paragraph, tender payment thereof to the Agency; or
    - 4.4.2 Deny liability in whole or in part and notify the Agency, citing the reasons therefore.
5. Provided Surety has proceeded under paragraphs 4.1, 4.2, or 4.3, the Agency shall pay the Balance of the Contract Sum to either:
  - 5.1 Surety in accordance with the terms of the Contract; or
  - 5.2 Another contractor selected pursuant to paragraph 4.3 to perform the Contract.
  - 5.3 The balance of the Contract Sum due either the Surety or another contractor shall be reduced by the amount of damages as described in paragraph 7.
6. If the Surety does not proceed as provided in paragraph 4 with reasonable promptness, the Surety shall be deemed to be in default on this Bond 15 days after receipt of written notice from the Agency to the Surety demanding that the Surety perform its obligations under this Bond, and the Agency shall be entitled to enforce any remedy available to the Agency.
  - 6.1 If the Surety proceeds as provided in paragraph 4.4 and the Agency refuses the payment tendered or the Surety has denied liability, in whole or in part, then without further notice the Agency shall be entitled to enforce any remedy available to the Agency.
  - 6.2 Any dispute, suit, action or proceeding arising out of or relating to this Bond shall be governed by the Dispute Resolution process defined in the Contract Documents and the laws of the State of South Carolina.
7. After the Agency has terminated the Contractor's right to complete the Contract, and if the Surety elects to act under paragraph 4.1, 4.2, or 4.3 above, then the responsibilities of the Surety to the Agency shall be those of the Contractor under the Contract, and the responsibilities of the Agency to the Surety shall those of the Agency under the Contract. To a limit of the amount of this Bond, but subject to commitment by the Agency of the Balance of the Contract Sum to mitigation of costs and damages on the Contract, the Surety is obligated to the Agency without duplication for:
  - 7.1 The responsibilities of the Contractor for correction of defective Work and completion of the Contract; and
  - 7.2 Additional legal, design professional and delay costs resulting from the Contractor's Default, and resulting from the actions or failure to act of the Surety under paragraph 4; and
  - 7.3 Damages awarded pursuant to the Dispute Resolution Provisions of the Contract. Surety may join in any Dispute Resolution proceeding brought under the Contract and shall be bound by the results thereof; and
  - 7.4 Liquidated Damages, or if no Liquidated Damages are specified in the Contract, actual damages caused by delayed performance or non-performance of the Contractor.
8. The Surety shall not be liable to the Agency or others for obligations of the Contractor that are unrelated to the Contract, and the Balance of the Contract Sum shall not be reduced or set-off on account of any such unrelated obligations. No right of action shall accrue on this Bond to any person or entity other than the Agency or its heirs, executors, administrators, or successors.
9. The Surety hereby waives notice of any change, including changes of time, to the contract or to related subcontracts, purchase orders and other obligations.
10. Notice to the Surety, the Agency or the Contractor shall be mailed or delivered to the address shown on the signature page.
11. Definitions
  - 11.1 Balance of the Contract Sum: The total amount payable by the Agency to the Contractor under the Contract after all proper adjustments have been made, including allowance to the Contractor of any amounts to be received by the Agency in settlement of insurance or other Claims for damages to which the Contractor is entitled, reduced by all valid and proper payments made to or on behalf of the Contractor under the Contract.
  - 11.2 Contractor Default: Failure of the Contractor, which has neither been remedied nor waived, to perform the Contract or otherwise to comply with the terms of the Contract.

# SE-357 LABOR & MATERIAL PAYMENT BOND

KNOW ALL MEN BY THESE PRESENTS, that *(Insert full name or legal title and address of Contractor)*

Name: \_\_\_\_\_  
Address: \_\_\_\_\_  
\_\_\_\_\_

hereinafter referred to as "Contractor", and *(Insert full name and address of principal place of business of Surety)*

Name: \_\_\_\_\_  
Address: \_\_\_\_\_  
\_\_\_\_\_

hereinafter called the "surety", are jointly and severally held and firmly bound unto *(Insert full name and address of Agency)*

Name: Coastal Carolina University  
Address: P.O. Box 261954  
Conway, SC 29528-6054

hereinafter referred to as "Agency", or its successors or assigns, the sum of \_\_\_\_\_ (\$ \_\_\_\_\_), being the sum of the Bond to which payment to be well and truly made, the Contractor and Surety bind themselves, their heirs, executors, administrators, successors and assigns, jointly and severally, firmly by these presents.

**WHEREAS**, Contractor has by written agreement dated \_\_\_\_\_ entered into a contract with Agency to construct

State Project Name: Ingle Hall Flooring 2024  
State Project Number: H17-N150-CB  
Brief Description of Awarded Work: Demo, prepare, and replace all flooring in 16 2nd and 3rd floor 4-bedroom suites including 202, 203, 220, 221, 246, 247, 264, 265, 302, 303, 320, 321, 346, 347, 364, and 365 as well as all flooring in 128 2nd and 3rd floor bedrooms (restroom flooring is not to be replaced). Also demo, prepare, and replace flooring in lobby with specified porcelain tile.

in accordance with Drawings and Specifications prepared by *(Insert full name and address of A/E)*

Name: Coastal Carolina University  
Address: P.O. Box 261954  
Conway, SC 29528-6054

which agreement is by reference made a part hereof, and is hereinafter referred to as the Contract.

**IN WITNESS WHEREOF**, Surety and Contractor, intending to be legally bound hereby, subject to the terms stated herein, do each cause this Labor & Material Payment Bond to be duly executed on its behalf by its authorized officer, agent or representative.

**DATED this** \_\_\_\_\_ **day of** \_\_\_\_\_, **2** \_\_\_\_\_ **BOND NUMBER** \_\_\_\_\_  
*(shall be no earlier than Date of Contract)*

**CONTRACTOR**

By: \_\_\_\_\_  
(Seal)

Print Name: \_\_\_\_\_

Print Title: \_\_\_\_\_

Witness: \_\_\_\_\_

**SURETY**

By: \_\_\_\_\_  
(Seal)

Print Name: \_\_\_\_\_

Print Title: \_\_\_\_\_  
*(Attach Power of Attorney)*

Witness: \_\_\_\_\_

*(Additional Signatures, if any, appear on attached page)*

**SE-357****LABOR & MATERIAL PAYMENT BOND****NOW, THEREFORE, THE CONDITION OF THIS OBLIGATION IS SUCH THAT:**

1. The Contractor and the Surety, jointly and severally, bind themselves, their heirs, executors, administrators, successors and assigns to the Agency to pay for all labor, materials and equipment required for use in the performance of the Contract, which is incorporated herein by reference.
  2. With respect to the Agency, this obligation shall be null and void if the Contractor:
    - 2.1 Promptly makes payment, directly or indirectly, for all sums due Claimants; and
    - 2.2 Defends, indemnifies and holds harmless the Agency from all claims, demands, liens or suits by any person or entity who furnished labor, materials or equipment for use in the performance of the Contract.
  3. With respect to Claimants, this obligation shall be null and void if the Contractor promptly makes payment, directly or indirectly, for all sums due.
  4. With respect to Claimants, and subject to the provisions of Title 29, Chapter 5 and the provisions of §11-35-3030(2)(c) of the SC Code of Laws, as amended, the Surety's obligation under this Bond shall arise as follows:
    - 4.1 Every person who has furnished labor, material or rental equipment to the Contractor or its subcontractors for the work specified in the Contract, and who has not been paid in full therefore before the expiration of a period of ninety (90) days after the date on which the last of the labor was done or performed by him or material or rental equipment was furnished or supplied by him for which such claim is made, shall have the right to sue on the payment bond for the amount, or the balance thereof, unpaid at the time of institution of such suit and to prosecute such action for the sum or sums justly due him.
    - 4.2 A remote claimant shall have a right of action on the payment bond upon giving written notice by certified or registered mail to the Contractor within ninety (90) days from the date on which such person did or performed the last of the labor or furnished or supplied the last of the material or rental equipment upon which such claim is made.
    - 4.3 Every suit instituted upon a payment bond shall be brought in a court of competent jurisdiction for the county or circuit in which the construction contract was to be performed, but no such suit shall be commenced after the expiration of one year after the day on which the last of the labor was performed or material or rental equipment was supplied by the person bringing suit.
  5. When the Claimant has satisfied the conditions of paragraph 4, the Surety shall promptly and at the Surety's expense take the following actions:
    - 5.1 Send an answer to the Claimant, with a copy to the Agency, within sixty (60) days after receipt of the claim, stating the amounts that are undisputed and the basis for challenging any amounts that are disputed.
    - 5.2 Pay or arrange for payment of any undisputed amounts.
    - 5.3 The Surety's failure to discharge its obligations under this paragraph 5 shall not be deemed to constitute a waiver of defenses the Surety or Contractor may have or acquire as to a claim. However, if the Surety fails to discharge its obligations under this paragraph 5, the Surety shall indemnify the Claimant for the reasonable attorney's fees the Claimant incurs to recover any sums found to be due and owing to the Claimant.
  6. Amounts owed by the Agency to the Contractor under the Contract shall be used for the performance of the Contract and to satisfy claims, if any, under any Performance Bond. By the Contractor furnishing and the Agency accepting this Bond, they agree that all funds earned by the contractor in the performance of the Contract are dedicated to satisfy obligations of the Contractor and the Surety under this Bond, subject to the Agency's prior right to use the funds for the completion of the Work.
  7. The Surety shall not be liable to the Agency, Claimants or others for obligations of the Contractor that are unrelated to the Contract. The Agency shall not be liable for payment of any costs or expenses of any claimant under this bond, and shall have under this Bond no obligations to make payments to, give notices on behalf of, or otherwise have obligations to Claimants under this Bond.
  8. The Surety hereby waives notice of any change, including changes of time, to the Contract or to related Subcontracts, purchase orders and other obligations.
  9. Notice to the Surety, the Agency or the Contractor shall be mailed or delivered to the addresses shown on the signature page. Actual receipt of notice by Surety, the Agency or the contractor, however accomplished, shall be sufficient compliance as of the date received at the address shown on the signature page.
  10. By the Contractor furnishing and the Agency accepting this Bond, they agree that this Bond has been furnished to comply with the statutory requirements of the South Carolina Code of Laws, as amended, and further, that any provision in this Bond conflicting with said statutory requirements shall be deemed deleted herefrom and provisions conforming to such statutory or other legal requirement shall be deemed incorporated herein. The intent is that this Bond shall be construed as a statutory Bond and not as a common law bond.
  11. Upon request of any person or entity appearing to be a potential beneficiary of this bond, the Contractor shall promptly furnish a copy of this Bond or shall permit a copy to be made.
  12. Any dispute, suit, action or proceeding arising out of or relating to this Bond shall be governed by the laws of the State of South Carolina.
- 13. DEFINITIONS**
- 13.1 Claimant: An individual or entity having a direct contract with the Contractor or with a Subcontractor of the Contractor to furnish labor, materials, or equipment for use in the performance of the Contract. The intent of this Bond shall be to include without limitation in the terms "labor, materials or equipment" that part of water, gas, power, light, heat, oil, gasoline, telephone service or rental equipment used in the Contract, architectural and engineering services required for performance of the Work of the Contractor and the Contractor's Subcontractors, and all other items for which a mechanic's lien might otherwise be asserted.
  - 13.2 Remote Claimant: A person having a direct contractual relationship with a subcontractor of the Contractor or subcontractor, but no contractual relationship expressed or implied with the Contractor.
  - 13.3 Contract: The agreement between the Agency and the Contractor identified on the signature page, including all Contract Documents and changes thereto.

**SE-380**

CHANGE ORDER NO.: \_\_\_\_\_

**CHANGE ORDER TO DESIGN-BID-BUILD CONTRACT**

**AGENCY:** Coastal Carolina University

**PROJECT NAME:** Ingle Hall Flooring 2024

**PROJECT NUMBER:** H17-N150-CB

**CONTRACTOR:** \_\_\_\_\_

**This Contract is changed as follows:** *(Insert description of change in space provided below.)*

**ADJUSTMENTS IN THE CONTRACT SUM:**

1. Original Contract Sum:		\$
2. Change in Contract Sum by previously approved Change Orders:		
3. Contract Sum prior to this Change Order:		\$ 0.00
4. Amount of this Change Order:		
5. New Contract Sum, including this Change Order:		\$ 0.00

**ADJUSTMENTS IN THE CONTRACT TIME:**

1. Initial Date for Substantial Completion:		
2. Sum of previously approved increases and decreases in Days:		Days
3. Change in Days for this Change Order:		Days
4. Total Number of Days added to this Contract including this Change Order:	0 Days	
5. New Date for Substantial Completion:		

**AGENCY ACCEPTANCE AND CERTIFICATION:**

I certify that the Agency has authorized, unencumbered funds available for obligation to this contract.

**BY:** \_\_\_\_\_ **Date:** \_\_\_\_\_  
*(Signature of Representative)*

**Print Name of Representative:** \_\_\_\_\_

Change is within Agency Construction Contract Change Order Certification of: \$ \_\_\_\_\_ Yes  No

**APPROVED BY:** \_\_\_\_\_ **DATE:** \_\_\_\_\_  
*(OSE Project Manager)*

**SUBMIT THE FOLLOWING TO OSE**

- SE-380, completed and signed by the Agency.
- SE-380, Page 2, completed and signed by the Contractor, A/E and Agency, with back-up information to support request.

**CHANGE ORDER REQUEST SUMMARY – DESIGN-BID-BUILD**

**AGENCY:** Coastal Carolina University

**PROJECT NAME:** Ingle Hall Flooring 2024

**PROJECT NUMBER:** H17-N150-CB

**CONTRACTOR:** \_\_\_\_\_

**This Contract is requested to be changed as follows:** *(Insert description of change in space provided below.)*

**ADJUSTMENTS IN THE CONTRACT TIME:** Requested Change in Days for this Change Order: \_\_\_\_\_ Days

			(1) Contractor	(2) Subcontractor	(3) TOTAL
<b>Direct Costs</b> (Provide back-up, including hourly rates, invoices, manhours, etc.)	1.	Labor			
	2.	Materials (including Sales Tax)			
	3.	Rental Charges			
	4.	Subtotal Direct Costs (sum lines 1 – 3)	\$ 0.00	\$ 0.00	\$ 0.00
<b>Contractor Markup</b> (per AIA A201, Section 7.1.5)	5.	Contractor OH&P (not to exceed 17% of line 4, col 1)			
	6.	Subcontractor’s OH&P (not to exceed 17% of line 4, col 2)			
	7.	Contractor markup on Subcontractor (not to exceed 10% of line 4, col 2)			
	8.	Total Contractor Markup (sum lines 5 – 7)	\$ 0.00	\$ 0.00	\$ 0.00
<b>Additional Bonding, Insurance and Permit Costs Associated with Change Order</b>	9.	Bonds			
	10.	Insurance			
	11.	Permits, Licenses or Fees			
	12.	Subtotal (sum lines 9 – 11)	\$ 0.00	\$ 0.00	\$ 0.00
<b>TOTAL</b>	13.	Change Order Cost (sum lines 4, 8, 12, col 3)			\$ 0.00

**ADJUSTMENTS IN THE CONTRACT SUM:** Amount of this Change Order Request: \$ \_\_\_\_\_

**CONTRACTOR ACCEPTANCE:**

BY: \_\_\_\_\_ Date: \_\_\_\_\_  
*(Signature of Representative)*

Print Name of Representative: \_\_\_\_\_

**A/E RECOMMENDATION FOR ACCEPTANCE:**

BY: \_\_\_\_\_ Date: \_\_\_\_\_  
*(Signature of Representative)*

Print Name of Representative: \_\_\_\_\_

**AGENCY ACCEPTANCE:**

BY: \_\_\_\_\_ Date: \_\_\_\_\_  
*(Signature of Representative)*

Print Name of Representative: \_\_\_\_\_

**Instruction to Contractor:** Attach documentation as needed to justify the requested change to the contract and submit to A/E or Agency.



SECTION 011000 - SUMMARY

PART 1 - GENERAL

1.1 SUMMARY

A. Section Includes:

1. Project information.
2. Work covered by Contract Documents.
3. Access to site.
4. Coordination with occupants.
5. Work restrictions.
6. Specification and Drawing conventions.

1.2 PROJECT INFORMATION

A. Project Identification: Ingle Hall Flooring, H17-N150-CB.

1. Project Location: Ingle Hall, 160 Township Circle, Conway, SC

B. Owner: Coastal Carolina University

1. Owner's Representative: Paula Holt

1.3 WORK COVERED BY CONTRACT DOCUMENTS

A. The Work of Project is defined by the Contract Documents and consists of the following: Demo, prepare, and replace all flooring in 16 2<sup>nd</sup> and 3<sup>rd</sup> floor 4-bedroom suites including 202, 203, 220, 221, 246, 247, 264, 265, 302, 303, 320, 321, 346, 347, 364, and 365. Also demo, prepare, and replace all flooring in 128 2<sup>nd</sup> and 3<sup>rd</sup> floor bedrooms. Also demo, prepare, and replace flooring in lobby with specified porcelain tile.

B. Square Footages for each building: See floor plans. Square footages must be field verified.

C. Owner will responsible for removing all furniture, appliances and associated items in each building.

D. Contractor will be responsible for disposal of all flooring materials removed from building units. (Owner will not provide a dumpster for this project).

E. Type of Contract:

1. Project will be constructed under a single prime contract.

1.4 INSTALLATION SCHEDULE

A. **May 28 to July 1, 2024**

## 1.5 ACCESS TO SITE

- A. General: Contractor shall have limited use of Project site for construction operations as indicated on Drawings by the Contract limits and as indicated by requirements of this Section.
  - 1. Driveways, Walkways, and Entrances: Keep driveways and entrances serving premises clear and available to Owner, Owner's employees, and emergency vehicles at all times. Do not use these areas for parking or for storage of materials.

## 1.6 COORDINATION WITH OCCUPANTS

- A. Full Owner Occupancy: The building units to have floors replaced will be un-occupied during the time of the contract.

## 1.7 WORK RESTRICTIONS

- A. Work Restrictions, General: Comply with restrictions on construction operations.
  - 1. Comply with limitations on use of public streets and with other requirements of authorities having jurisdiction.
- B. On-Site Work Hours: Limit work in the existing building to normal business working hours of 7:00 a.m. to 5:00 p.m., Monday through Friday, unless otherwise indicated.
- C. Existing Utility Interruptions: Do not interrupt utilities serving facilities occupied by Owner or others unless permitted under the following conditions and then only after providing temporary utility services according to requirements indicated:
  - 1. Notify Architect / Owner not less than 2 days in advance of proposed utility interruptions.
  - 2. Obtain Architect / Owners written permission before proceeding with utility interruptions.
- D. Restricted Substances: Use of tobacco products and other controlled substances on campus is not permitted.

## 1.8 SPECIFICATION AND DRAWING CONVENTIONS

- A. Specification Content: The Specifications use certain conventions for the style of language and the intended meaning of certain terms, words, and phrases when used in particular situations. These conventions are as follows:
  - 1. Imperative mood and streamlined language are generally used in the Specifications. The words "shall," "shall be," or "shall comply with," depending on the context, are implied where a colon (:) is used within a sentence or phrase.
  - 2. Specification requirements are to be performed by Contractor unless specifically stated otherwise.

- B. Division 01 General Requirements: Requirements of Sections in Division 01 apply to the Work of all Sections in the Specifications.

PART 2 - PRODUCTS (Not Used)

PART 3 - EXECUTION (Not Used)

END OF SECTION 011000

## SECTION 012500 - SUBSTITUTION PROCEDURES

## PART 1 - GENERAL

## 1.1 SUMMARY

- A. Section includes administrative and procedural requirements for substitutions.

## 1.2 DEFINITIONS

- A. Substitutions: Changes in products, materials, equipment, and methods of construction from those required by the Contract Documents and proposed by Contractor.
  - 1. Substitutions for Cause: Changes proposed by Contractor that are required due to changed Project conditions, such as unavailability of product, regulatory changes, or unavailability of required warranty terms.
  - 2. Substitutions for Convenience: Changes proposed by Contractor or Owner that are not required in order to meet other Project requirements but may offer advantage to Contractor or Owner.

## 1.3 ACTION SUBMITTALS

- A. Substitution Requests: Submit one copy in .pdf of each request for consideration. Identify product or fabrication or installation method to be replaced. Include Specification Section number and title and Drawing numbers and titles.
  - 1. Documentation: Show compliance with requirements for substitutions and the following, as applicable:
    - a. Statement indicating why specified product or fabrication or installation method cannot be provided, if applicable.
    - b. Coordination of information, including a list of changes or revisions needed to other parts of the Work and to construction performed by Owner and separate contractors that will be necessary to accommodate proposed substitution.
    - c. Detailed comparison of significant qualities of proposed substitutions with those of the Work specified. Include annotated copy of applicable Specification Section. Significant qualities may include attributes, such as performance, weight, size, durability, visual effect, sustainable design characteristics, warranties, and specific features and requirements indicated. Indicate deviations, if any, from the Work specified.
    - d. Product Data, including drawings and descriptions of products and fabrication and installation procedures.
    - e. Samples, where applicable or requested.
    - f. Certificates and qualification data, where applicable or requested.
    - g. List of similar installations for completed projects, with project names and addresses as well as names and addresses of architects and owners.

- h. Material test reports from a qualified testing agency, indicating and interpreting test results for compliance with requirements indicated.
      - i. Detailed comparison of Contractor's construction schedule using proposed substitutions with products specified for the Work, including effect on the overall Contract Time. If specified product or method of construction cannot be provided within the Contract Time, include letter from manufacturer, on manufacturer's letterhead, stating date of receipt of purchase order, lack of availability, or delays in delivery.
      - j. Cost information, including a proposal of change, if any, in the Contract Sum.
      - k. Contractor's certification that proposed substitution complies with requirements in the Contract Documents, except as indicated in substitution request, is compatible with related materials and is appropriate for applications indicated.
      - l. Contractor's waiver of rights to additional payment or time that may subsequently become necessary because of failure of proposed substitution to produce indicated results.
2. Architect's Action: If necessary, Architect will request additional information or documentation for evaluation within five days of receipt of a request for substitution. Architect will notify Contractor of acceptance or rejection of proposed substitution within ten days of receipt of request, or five days of receipt of additional information or documentation, whichever is later.
  - a. Forms of Acceptance: Change Order, Construction Change Directive, or Architect's Supplemental Instructions for minor changes in the Work.
  - b. Use product specified if Architect does not issue a decision on use of a proposed substitution within time allocated.

#### 1.4 QUALITY ASSURANCE

- A. Compatibility of Substitutions: Investigate and document compatibility of proposed substitution with related products and materials. Engage a qualified testing agency to perform compatibility tests recommended by manufacturers.

#### 1.5 PROCEDURES

- A. Coordination: Revise or adjust affected work as necessary to integrate work of the approved substitutions.

#### 1.6 SUBSTITUTIONS

- A. Substitutions for Cause: Submit requests for substitution immediately on discovery of need for change, but not later than ten days prior to time required for preparation and review of related submittals.
  1. Conditions: Architect will consider Contractor's request for substitution when the following conditions are satisfied. If the following conditions are not satisfied, Architect will return requests without action, except to record noncompliance with these requirements:

- a. Requested substitution is consistent with the Contract Documents and will produce indicated results.
- b. Substitution request is fully documented and properly submitted.
- c. Requested substitution will not adversely affect Contractor's construction schedule.
- d. Requested substitution has received necessary approvals of authorities having jurisdiction.
- e. Requested substitution is compatible with other portions of the Work.
- f. Requested substitution has been coordinated with other portions of the Work.
- g. Requested substitution provides specified warranty.
- h. If requested substitution involves more than one contractor, requested substitution has been coordinated with other portions of the Work, is uniform and consistent, is compatible with other products, and is acceptable to all contractors involved.

B. Substitutions for Convenience: Not allowed.

PART 2 - PRODUCTS (Not Used)

PART 3 - EXECUTION (Not Used)

END OF SECTION 012500



## SECTION 012600 - CONTRACT MODIFICATION PROCEDURES

## PART 1 - GENERAL

## 1.1 SUMMARY

- A. Section includes administrative and procedural requirements for handling and processing Contract modifications.

## 1.2 MINOR CHANGES IN THE WORK

- A. Architect will issue supplemental instructions authorizing minor changes in the Work, not involving adjustment to the Contract Sum or the Contract Time, on AIA Document G710.

## 1.3 PROPOSAL REQUESTS

- A. Owner-Initiated Proposal Requests: Architect will issue a detailed description of proposed changes in the Work that may require adjustment to the Contract Sum or the Contract Time. If necessary, the description will include supplemental or revised Drawings and Specifications.

1. Work Change Proposal Requests issued by Architect are not instructions either to stop work in progress or to execute the proposed change.
2. Within time specified in Proposal Request after receipt of Proposal Request, submit a quotation estimating cost adjustments to the Contract Sum and the Contract Time necessary to execute the change.
  - a. Include a list of quantities of products required or eliminated and unit costs, with total amount of purchases and credits to be made.
  - b. Indicate applicable taxes, delivery charges, equipment rental, and amounts of trade discounts.
  - c. Include costs of labor and supervision directly attributable to the change.
  - d. Include an updated Contractor's construction schedule that indicates the effect of the change, including, but not limited to, changes in activity duration, start and finish times, and activity relationship. Use available total float before requesting an extension of the Contract Time.

- B. Contractor-Initiated Proposals: If latent or changed conditions require modifications to the Contract, Contractor may initiate a claim by submitting a request for a change to Architect.

1. Include a statement outlining reasons for the change and the effect of the change on the Work. Provide a complete description of the proposed change. Indicate the effect of the proposed change on the Contract Sum and the Contract Time.
2. Include a list of quantities of products required or eliminated and unit costs, with total amount of purchases and credits to be made. Indicate applicable taxes, delivery charges, equipment rental, and amounts of trade discounts.
3. Include costs of labor and supervision directly attributable to the change.

4. Include an updated Contractor's construction schedule that indicates the effect of the change, including, but not limited to, changes in activity duration, start and finish times, and activity relationship. Use available total float before requesting an extension of the Contract Time.
5. Comply with requirements in Section 012500 "Substitution Procedures" if the proposed change requires substitution of one product or system for product or system specified.

#### 1.4 CHANGE ORDER PROCEDURES

- A. On Owner's approval of a Work Change Proposal Request, Architect will issue a Change Order for signatures of Owner and Contractor on SE-380 Change Order to Design-Bid-Build Construction Contract.

PART 2 - PRODUCTS (Not Used)

PART 3 - EXECUTION (Not Used)

END OF SECTION 012600

## SECTION 012900 - PAYMENT PROCEDURES

## PART 1 - GENERAL

## 1.1 SUMMARY

- A. Section includes administrative and procedural requirements necessary to prepare and process Applications for Payment.

## 1.2 SCHEDULE OF VALUES

- A. Coordination: Coordinate preparation of the schedule of values with preparation of Contractor's construction schedule.
  - 1. Coordinate line items in the schedule of values with items required to be indicated as separate activities in Contractor's construction schedule.
  - 2. Submit the schedule of values to Architect at earliest possible date, but no later than seven days before the date scheduled for submittal of initial Applications for Payment.
- B. Format and Content: Use Masterspec guide to establish line items for the schedule of values.
  - 1. Arrange schedule of values consistent with format of AIA Document G703.
  - 2. Provide a breakdown of the Contract Sum in enough detail to facilitate continued evaluation of Applications for Payment and progress reports. Provide multiple line items for principal subcontract amounts in excess of five percent of the Contract Sum.
  - 3. Provide a separate line item in the schedule of values for each part of the Work where Applications for Payment may include materials or equipment purchased or fabricated and stored, but not yet installed. Differentiate between items stored on-site and items stored off-site.
  - 4. Overhead Costs: Include total cost and proportionate share of general overhead and profit for each line item.
  - 5. Overhead Costs: Show cost of temporary facilities and other major cost items that are not direct cost of actual work-in-place as separate line items.
  - 6. Closeout Costs. Include separate line items under Contractor and principal subcontracts for Project closeout requirements in an amount totaling five percent of the Contract Sum and subcontract amount.
  - 7. Schedule of Values Revisions: Revise the schedule of values when Change Orders or Construction Change Directives result in a change in the Contract Sum. Include at least one separate line item for each Change Order.

## 1.3 APPLICATIONS FOR PAYMENT

- A. Each Application for Payment following the initial Application for Payment shall be consistent with previous applications and payments as certified by Architect and paid for by Owner.

- B. Payment Application Times: Submit Application for Payment to Architect by the first of the month. The period covered by each Application for Payment is one month, ending on the last day of the month.
1. Submit draft copy of Application for Payment seven days prior to due date for review by Architect.
- C. Application for Payment Forms: Use AIA Document G702 and AIA Document G703 as form for Applications for Payment.
- D. Application Preparation: Complete every entry on form. Notarize and execute by a person authorized to sign legal documents on behalf of Contractor. Architect will return incomplete applications without action.
1. Entries shall match data on the schedule of values and Contractor's construction schedule. Use updated schedules if revisions were made.
  2. Include amounts for work completed following previous Application for Payment, whether or not payment has been received. Include only amounts for work completed at time of Application for Payment.
  3. Include amounts of Change Orders issued before last day of construction period covered by application.
- E. Transmittal: Submit signed and notarized original copy of each Application for Payment to Architect by electronic format including waivers of lien and similar attachments if required.
- F. Initial Application for Payment: Administrative actions and submittals that must precede or coincide with submittal of first Application for Payment include the following:
1. List of subcontractors.
  2. Schedule of values.
  3. Contractor's construction schedule (preliminary if not final).
  4. Products list (preliminary if not final).
  5. Submittal schedule (preliminary if not final).
  6. List of Contractor's staff assignments.
  7. List of Contractor's principal consultants.
  8. Initial progress report.
  9. Report of preconstruction conference.
- G. Application for Payment at Substantial Completion: After Architect issues the Certificate of Substantial Completion, submit an Application for Payment showing 100 percent completion for portion of the Work claimed as substantially complete.
1. Include documentation supporting claim that the Work is substantially complete and a statement showing an accounting of changes to the Contract Sum.
  2. This application shall reflect Certificate(s) of Substantial Completion issued previously for Owner occupancy of designated portions of the Work.
- H. Final Payment Application: After completing Project closeout requirements, submit final Application for Payment with releases and supporting documentation not previously submitted and accepted, including, but not limited, to the following:

1. Evidence of completion of Project closeout requirements.
2. Insurance certificates for products and completed operations where required and proof that taxes, fees, and similar obligations were paid.
3. Updated final statement, accounting for final changes to the Contract Sum.
4. AIA Document G706.
5. AIA Document G706A.
6. AIA Document G707.
7. Evidence that claims have been settled.
8. Final liquidated damages settlement statement.

PART 2 - PRODUCTS (Not Used)

PART 3 - EXECUTION (Not Used)

END OF SECTION 012900

## SECTION 013100 - PROJECT MANAGEMENT AND COORDINATION

## PART 1 - GENERAL

## 1.1 RELATED DOCUMENTS

- A. Drawings and general provisions of the Contract, including General and Supplementary Conditions and other Division 01 Specification Sections, apply to this Section.

## 1.2 SUMMARY

- A. Section includes administrative provisions for coordinating construction operations on Project including, but not limited to, the following:
  - 1. General coordination procedures.
  - 2. Coordination drawings.
  - 3. RFIs.
  - 4. Project meetings.

## 1.3 DEFINITIONS

- A. RFI: Request for Information. Request from Owner, Architect, or Contractor seeking information required by or clarifications of the Contract Documents.

## 1.4 INFORMATIONAL SUBMITTALS

- A. Subcontract List: Prepare a written summary identifying individuals or firms proposed for each portion of the Work, including those who are to furnish products or equipment fabricated to a special design. Include the following information in tabular form:
  - 1. Name, address, telephone number, and email address of entity performing subcontract or supplying products.
  - 2. Number and title of related Specification Section(s) covered by subcontract.
  - 3. Drawing number and detail references, as appropriate, covered by subcontract.

## 1.5 GENERAL COORDINATION PROCEDURES

- A. Coordination: Coordinate construction operations to ensure efficient and orderly installation of each part of the Work. Coordinate construction operations that depend on each other for proper installation, connection, and operation.
  - 1. Schedule construction operations in sequence required to obtain the best results where installation of one part of the Work depends on installation of other components, before or after its own installation.



2. Coordinate installation of different components to ensure maximum performance and accessibility for required maintenance, service, and repair.
  3. Make adequate provisions to accommodate items scheduled for later installation.
- B. Administrative Procedures: Coordinate scheduling and timing of required administrative procedures with other construction activities to avoid conflicts and to ensure orderly progress of the Work. Such administrative activities include, but are not limited to, the following:
1. Preparation of Contractor's construction schedule.
  2. Preparation of the schedule of values.
  3. Installation and removal of temporary facilities and controls.
  4. Delivery and processing of submittals.
  5. Progress meetings.
  6. Project closeout activities.
  7. Startup and adjustment of systems.

#### 1.6 REQUEST FOR INFORMATION (RFI)

- A. General: Immediately on discovery of the need for additional information, clarification, or interpretation of the Contract Documents, Contractor shall prepare and submit an RFI in the form specified.
1. Architect will return without response those RFIs submitted to Architect by other entities controlled by Contractor.
  2. Coordinate and submit RFIs in a prompt manner so as to avoid delays in Contractor's work or work of subcontractors.
- B. Content of the RFI: Include a detailed, legible description of item needing information or interpretation and the following:
1. Project name.
  2. Project number.
  3. Date.
  4. Name of Contractor.
  5. Name of Architect.
  6. RFI number, numbered sequentially.
  7. RFI subject.
  8. Drawing number and detail references, as appropriate.
  9. Field dimensions and conditions, as appropriate.
  10. Contractor's suggested resolution. If Contractor's suggested resolution impacts the Contract Time or the Contract Sum, Contractor shall state impact in the RFI.
  11. Contractor's signature.
  12. Attachments: Include sketches, descriptions, measurements, photos, Product Data, Shop Drawings, coordination drawings, and other information necessary to fully describe items needing interpretation.
- C. RFI Forms: AIA Document G716.

- D. Architect's Action: Architect will review each RFI, determine action required, and respond. Allow seven working days for Architect's response for each RFI. RFIs received by Architect after 1:00 p.m. will be considered as received the following working day.
1. The following Contractor-generated RFIs will be returned without action:
    - a. Requests for approval of submittals.
    - b. Requests for approval of substitutions.
    - c. Requests for approval of Contractor's means and methods.
    - d. Requests for coordination information already indicated in the Contract Documents.
    - e. Requests for adjustments in the Contract Time or the Contract Sum.
    - f. Requests for interpretation of Architect's actions on submittals.
    - g. Incomplete RFIs or inaccurately prepared RFIs.
  2. Architect's action may include a request for additional information, in which case Architect's time for response will date from time of receipt by Architect of additional information.
  3. Architect's action on RFIs that may result in a change to the Contract Time or the Contract Sum may be eligible for Contractor to submit Change Proposal according to Section 012600 "Contract Modification Procedures."
    - a. If Contractor believes the RFI response warrants change in the Contract Time or the Contract Sum, notify Architect in writing within seven days of receipt of the RFI response.
- E. PDF Document Preparation: Where PDFs are required to be submitted to Architect, prepare as follows:
1. Assemble complete submittal package into a single indexed file incorporating submittal requirements of a single Specification Section and transmittal form with links enabling navigation to each item.
  2. Name file with submittal number or other unique identifier, including revision identifier.
  3. Certifications: Where digitally submitted certificates and certifications are required, provide a digital signature with digital certificate on where indicated.

## 1.7 PROJECT MEETINGS

- A. General: Schedule and conduct meetings and conferences at Project site unless otherwise indicated.
- B. Preconstruction Conference: Architect will schedule and conduct a preconstruction conference before starting construction, at a time convenient to Owner and Architect, but no later than 15 days after execution of the Agreement.
1. Attendees: Authorized representatives of Owner, Architect, and their consultants; inspection firm, Contractor and its superintendent; major subcontractors; suppliers; and other concerned parties shall attend the conference. Participants at the conference shall be familiar with Project and authorized to conclude matters relating to the Work.
  2. Agenda: Discuss items of significance that could affect progress, including the following:

- a. Responsibilities and personnel assignments.
  - b. Tentative construction schedule.
  - c. Critical work sequencing and long lead items.
  - d. Designation of key personnel and their duties.
  - e. Lines of communications.
  - f. Procedures for processing field decisions and Change Orders.
  - g. Procedures for RFIs.
  - h. Procedures for testing and inspecting.
  - i. Procedures for processing Applications for Payment.
  - j. Distribution of the Contract Documents.
  - k. Submittal procedures.
  - l. Preparation of Record Documents.
  - m. Use of the premises and existing building.
  - n. Work restrictions.
  - o. Working hours.
  - p. Owner's occupancy requirements.
  - q. Responsibility for temporary facilities and controls.
  - r. Procedures for disruptions and shutdowns.
  - s. Construction waste management and recycling.
  - t. Parking availability.
  - u. Office, work, and storage areas.
  - v. Equipment deliveries and priorities.
  - w. First aid.
  - x. Security.
  - y. Progress cleaning.
3. Minutes: Entity responsible for conducting meeting will record and distribute meeting minutes.

C. Progress Meetings: Conduct progress meetings regular intervals.

1. Coordinate dates of meetings with preparation of payment requests.
2. Attendees: In addition to representatives of Owner and Architect, each contractor, subcontractor, supplier, and other entity concerned with current progress or involved in planning, coordination, or performance of future activities shall be represented at these meetings. All participants at the meeting shall be familiar with Project and authorized to conclude matters relating to the Work.
3. Agenda: Review and correct or approve minutes of previous progress meeting. Review other items of significance that could affect progress. Include topics for discussion as appropriate to status of Project.
  - a. Contractor's Construction Schedule: Review progress since the last meeting. Determine whether each activity is on time, ahead of schedule, or behind schedule, in relation to Contractor's construction schedule. Determine how construction behind schedule will be expedited; secure commitments from parties involved to do so. Discuss whether schedule revisions are required to ensure that current and subsequent activities will be completed within the Contract Time.
    - 1) Review schedule for next period.
  - b. Review present and future needs of each entity present, including the following:

- 1) Interface requirements.
  - 2) Sequence of operations.
  - 3) Status of submittals.
  - 4) Deliveries.
  - 5) Access.
  - 6) Site use.
  - 7) Temporary facilities and controls.
  - 8) Progress cleaning.
  - 9) Quality and work standards.
  - 10) Status of correction of deficient items.
  - 11) Field observations.
  - 12) Status of RFIs.
  - 13) Status of Proposal Requests.
  - 14) Pending changes.
  - 15) Status of Change Orders.
  - 16) Pending claims and disputes.
  - 17) Documentation of information for payment requests.
4. Minutes: Entity responsible for conducting the meeting will record and distribute the meeting minutes to each party present and to parties requiring information.
- a. Schedule Updating: Revise Contractor's construction schedule after each progress meeting where revisions to the schedule have been made or recognized. Issue revised schedule concurrently with the report of each meeting.

PART 2 - PRODUCTS (Not Used)

PART 3 - EXECUTION (Not Used)

END OF SECTION 013100

## SECTION 013300 - SUBMITTAL PROCEDURES

### PART 1 - GENERAL

#### 1.1 SUMMARY

- A. Section Includes:
  - 1. Submittal schedule requirements.
  - 2. Administrative and procedural requirements for submittals.

#### 1.2 DEFINITIONS

- A. Action Submittals: Written and graphic information and physical samples that require Architect's responsive action. Action submittals are those submittals indicated in individual Specification Sections as "action submittals."
- B. Informational Submittals: Written and graphic information and physical samples that do not require Architect's responsive action. Submittals may be rejected for not complying with requirements. Informational submittals are those submittals indicated in individual Specification Sections as "informational submittals."

#### 1.3 SUBMITTAL SCHEDULE

- A. Submittal Schedule: Submit, as an action submittal, a list of submittals, arranged in chronological order by dates required by construction schedule. Include time required for review, ordering, manufacturing, fabrication, and delivery when establishing dates. Include additional time required for making corrections or revisions to submittals noted by Architect and additional time for handling and reviewing submittals required by those corrections.

#### 1.4 SUBMITTAL FORMATS

- A. Submittal Information: Include the following information in each submittal:
  - 1. Project name.
  - 2. Date.
  - 3. Name of Architect.
  - 4. Name of Contractor.
  - 5. Name of firm or entity that prepared submittal.
  - 6. Names of subcontractor, manufacturer, and supplier.
  - 7. Unique submittal number, including revision identifier. Category and type of submittal.
  - 8. Submittal purpose and description.
  - 9. Drawing number and detail references, as appropriate.
  - 10. Indication of full or partial submittal.
  - 11. Location(s) where product is to be installed, as appropriate.
  - 12. Other necessary identification.

13. Remarks.
  14. Signature of transmitter.
- B. Deviations and Additional Information: On each submittal, clearly indicate deviations from requirements in the Contract Documents, including minor variations and limitations; include relevant additional information and revisions, other than those requested by Architect on previous submittals. Indicate by highlighting on each submittal or noting on attached separate sheet.
- C. PDF Submittals: Prepare submittals as PDF package, incorporating complete information into each PDF file. Name PDF file with submittal number.

## 1.5 SUBMITTAL PROCEDURES

- A. Prepare and submit submittals required by individual Specification Sections. Types of submittals are indicated in individual Specification Sections.
1. Email: Prepare submittals as PDF package, and transmit to Architect by sending via email. Include PDF transmittal form. Include information in email subject line as requested by Architect.
- B. Coordination: Coordinate preparation and processing of submittals with performance of construction activities.
1. Coordinate each submittal with fabrication, purchasing, testing, delivery, other submittals, and related activities that require sequential activity.
  2. Submit all submittal items required for each Specification Section concurrently unless partial submittals for portions of the Work are indicated on approved submittal schedule.
  3. Submit action submittals and informational submittals required by the same Specification Section as separate packages under separate transmittals.
- C. Processing Time: Allow time for submittal review, including time for resubmittals, as follows. Time for review shall commence on Architect's receipt of submittal. No extension of the Contract Time will be authorized because of failure to transmit submittals enough in advance of the Work to permit processing, including resubmittals.
1. Initial Review: Allow 10 days for initial review of each submittal. Allow additional time if coordination with subsequent submittals is required. Architect will advise Contractor when a submittal being processed must be delayed for coordination.
  2. Resubmittal Review: Allow 10 days for review of each resubmittal.
- D. Resubmittals: Make resubmittals in same form as initial submittal.
- E. Distribution: Furnish copies of final submittals to manufacturers, subcontractors, suppliers, fabricators, installers, authorities having jurisdiction, and others as necessary for performance of construction activities. Show distribution on transmittal forms.
- F. Use for Construction: Retain complete copies of submittals on Project site. Use only final action submittals that are marked with approval notation from Architect's action stamp.

## 1.6 SUBMITTAL REQUIREMENTS

- A. Product Data: Collect information into a single submittal for each element of construction and type of product or equipment.
1. If information must be specially prepared for submittal because standard published data are unsuitable for use, submit as Shop Drawings, not as Product Data.
  2. Mark each copy of each submittal to show which products and options are applicable.
  3. Include the following information, as applicable:
    - a. Manufacturer's catalog cuts.
    - b. Manufacturer's product specifications.
    - c. Standard color charts.
    - d. Statement of compliance with specified referenced standards.
    - e. Testing by recognized testing agency.
    - f. Application of testing agency labels and seals.
    - g. Notation of coordination requirements.
    - h. Availability and delivery time information.
  4. For equipment, include the following in addition to the above, as applicable:
    - a. Wiring diagrams that show factory-installed wiring.
    - b. Printed performance curves.
    - c. Operational range diagrams.
    - d. Clearances required to other construction, if not indicated on accompanying Shop Drawings.
  5. Submit Product Data before Shop Drawings, and before or concurrent with Samples.
- B. Shop Drawings: Prepare Project-specific information, drawn accurately to scale. Do not base Shop Drawings on reproductions of the Contract Documents or standard printed data.
1. Preparation: Fully illustrate requirements in the Contract Documents. Include the following information, as applicable:
    - a. Identification of products.
    - b. Schedules.
    - c. Compliance with specified standards.
    - d. Notation of coordination requirements.
    - e. Notation of dimensions established by field measurement.
    - f. Relationship and attachment to adjoining construction clearly indicated.
    - g. Seal and signature of professional engineer if specified.
- C. Samples: Submit Samples for review of kind, color, pattern, and texture for a check of these characteristics with other materials.
1. Transmit Samples that contain multiple, related components such as accessories together in one submittal package.
  2. Identification: Permanently attach label on unexposed side of Samples that includes the following:



- a. Project name and submittal number.
  - b. Generic description of Sample.
  - c. Product name and name of manufacturer.
  - d. Sample source.
  - e. Number and title of applicable Specification Section.
  - f. Specification paragraph number and generic name of each item.
3. Email Transmittal: Provide PDF transmittal. Include digital image file illustrating Sample characteristics, and identification information for record.
  4. Disposition: Maintain sets of approved Samples at Project site, available for quality-control comparisons throughout the course of construction activity. Sample sets may be used to determine final acceptance of construction associated with each set.
    - a. Samples that may be incorporated into the Work are indicated in individual Specification Sections. Such Samples must be in an undamaged condition at time of use.
    - b. Samples not incorporated into the Work, or otherwise designated as Owner's property, are the property of Contractor.
  5. Samples for Initial Selection: Submit manufacturer's color charts consisting of units or sections of units showing the full range of colors, textures, and patterns available.
    - a. Number of Samples: Submit one full set of available choices where color, pattern, texture, or similar characteristics are required to be selected from manufacturer's product line. Architect will return submittal with options selected.
- D. Product Schedule: As required in individual Specification Sections, prepare a written summary indicating types of products required for the Work and their intended location. Include the following information in tabular form:
- E. Qualification Data: Prepare written information that demonstrates capabilities and experience of firm or person. Include lists of completed projects with project names and addresses, contact information of architects and owners, and other information specified.
- F. Design Data: Prepare and submit written and graphic information indicating compliance with indicated performance and design criteria in individual Specification Sections. Include list of assumptions and summary of loads. Include load diagrams if applicable. Provide name and version of software, if any, used for calculations. Number each page of submittal.
- G. Certificates:
1. Certificates and Certifications Submittals: Submit a statement that includes signature of entity responsible for preparing certification. Certificates and certifications shall be signed by an officer or other individual authorized to sign documents on behalf of that entity. Provide a notarized signature where indicated.
  2. Material Certificates: Submit written statements on manufacturer's letterhead certifying that material complies with requirements in the Contract Documents.
  3. Product Certificates: Submit written statements on manufacturer's letterhead certifying that product complies with requirements in the Contract Documents.

### 1.7 CONTRACTOR'S REVIEW

- A. Action Submittals and Informational Submittals: Review each submittal and check for coordination with other Work of the Contract and for compliance with the Contract Documents. Note corrections and field dimensions. Mark with approval stamp before submitting to Architect.
- B. Contractor's Approval: Indicate Contractor's approval for each submittal with a uniform approval stamp. Include name of reviewer, date of Contractor's approval, and statement certifying that submittal has been reviewed, checked, and approved for compliance with the Contract Documents.
  - 1. Architect will not review submittals received from Contractor that do not have Contractor's review and approval.

### 1.8 ARCHITECT'S REVIEW

- A. Action Submittals: Architect will review each submittal, indicate corrections or revisions required, and return it.
  - 1. PDF Submittals: Architect will indicate, via markup on each submittal, the appropriate action.
- B. Informational Submittals: Architect will review each submittal and will not return it, or will return it if it does not comply with requirements. Architect will forward each submittal to appropriate party.
- C. Partial submittals prepared for a portion of the Work will be reviewed when use of partial submittals has received prior approval from Architect.
- D. Incomplete submittals are unacceptable, will be considered nonresponsive, and will be returned for resubmittal without review.
- E. Architect will discard submittals received from sources other than Contractor.
- F. Submittals not required by the Contract Documents will be returned by Architect without action.

PART 2 - PRODUCTS (Not Used)

PART 3 - EXECUTION (Not Used)

END OF SECTION 013300

## SECTION 017700 - CLOSEOUT PROCEDURES

### PART 1 - GENERAL

#### 1.1 SUMMARY

- A. Section includes administrative and procedural requirements for contract closeout, including, but not limited to, the following:
  - 1. Substantial Completion procedures.
  - 2. Final completion procedures.
  - 3. Warranties.
  - 4. Final cleaning.
  - 5. Repair of the Work.

#### 1.2 ACTION SUBMITTALS

- A. Contractor's List of Incomplete Items: Initial submittal at Substantial Completion.
- B. Certified List of Incomplete Items: Final submittal at final completion.

#### 1.3 CLOSEOUT SUBMITTALS

- A. Certificates of Release: From authorities having jurisdiction.
- B. Certificate of Insurance: For continuing coverage.

#### 1.4 SUBSTANTIAL COMPLETION PROCEDURES

- A. Contractor's List of Incomplete Items: Prepare and submit a list of items to be completed and corrected (Contractor's punch list), indicating the value of each item on the list and reasons why the Work is incomplete.
- B. Submittals Prior to Substantial Completion: Complete the following a minimum of seven days prior to requesting inspection for determining date of Substantial Completion. List items below that are incomplete at time of request.
  - 1. Certificates of Release: Obtain and submit releases from authorities having jurisdiction permitting Owner unrestricted use of the Work and access to services and utilities. Include occupancy permits, operating certificates, and similar releases.
  - 2. Submit closeout submittals specified in other Division 01 Sections, including project record documents, operation and maintenance manuals, damage or settlement surveys, property surveys, and similar final record information.
  - 3. Submit closeout submittals specified in individual Sections, including specific warranties, workmanship bonds, maintenance service agreements, final certifications, and similar documents.

- C. Procedures Prior to Substantial Completion: Complete the following a minimum of ten days prior to requesting inspection for determining date of Substantial Completion. List items below that are incomplete at time of request.
  - 1. Terminate and remove temporary facilities from Project site, construction tools, and similar elements.
  - 2. Complete final cleaning requirements.
  - 3. Touch up paint and otherwise repair and restore marred exposed finishes to eliminate visual defects.
  
- D. Inspection: Submit a written request for inspection to determine Substantial Completion a minimum of ten days prior to date the Work will be completed and ready for final inspection and tests. On receipt of request, Architect will either proceed with inspection or notify Contractor of unfulfilled requirements. Architect will prepare the Certificate of Substantial Completion after inspection or will notify Contractor of items, either on Contractor's list or additional items identified by Architect, that must be completed or corrected before certificate will be issued.

#### 1.5 FINAL COMPLETION PROCEDURES

- A. Submittals Prior to Final Completion: Before requesting final inspection for determining final completion, complete the following:
  - 1. Submit a final Application for Payment according to Section 012900 "Payment Procedures."
  - 2. Certified List of Incomplete Items: Submit certified copy of Architect's Substantial Completion inspection list of items to be completed or corrected (punch list), endorsed and dated by Architect. Certified copy of the list shall state that each item has been completed or otherwise resolved for acceptance.
  - 3. Certificate of Insurance: Submit evidence of final, continuing insurance coverage complying with insurance requirements.
  
- B. Inspection: Submit a written request for final inspection to determine acceptance a minimum of 10 days prior to date the work will be completed and ready for final inspection and tests. On receipt of request, Architect will either proceed with inspection or notify Contractor of unfulfilled requirements. Architect will prepare a final Certificate for Payment after inspection or will notify Contractor of construction that must be completed or corrected before certificate will be issued.

#### 1.6 LIST OF INCOMPLETE ITEMS (PUNCH LIST)

- A. Organization of List: Include name and identification of each space and area affected by construction operations for incomplete items and items needing correction including, if necessary, areas disturbed by Contractor that are outside the limits of construction.
  - 1. Organize list of spaces in sequential order.
  - 2. Submit list of incomplete items in the following format:
    - a. PDF electronic file. Architect will return annotated file.

## 1.7 SUBMITTAL OF PROJECT WARRANTIES

- A. Time of Submittal: Submit written warranties on request of Architect for designated portions of the Work where warranties are indicated to commence on dates other than date of Substantial Completion, or when delay in submittal of warranties might limit Owner's rights under warranty.
- B. Organize warranty documents into an orderly sequence based on the table of contents of Project Manual.
- C. Warranty Electronic File: Provide warranties and bonds in PDF format. Assemble complete warranty and bond submittal package into a single electronic PDF file with bookmarks enabling navigation to each item. Provide bookmarked table of contents at beginning of document.
- D. Provide additional copies of each warranty to include in operation and maintenance manuals.

## PART 2 - PRODUCTS

### 2.1 MATERIALS

- A. Cleaning Agents: Use cleaning materials and agents recommended by manufacturer or fabricator of the surface to be cleaned. Do not use cleaning agents that are potentially hazardous to health or property or that might damage finished surfaces.

## PART 3 - EXECUTION

### 3.1 FINAL CLEANING

- A. General: Perform final cleaning. Conduct cleaning and waste-removal operations to comply with local laws and ordinances and Federal and local environmental and antipollution regulations.
- B. Cleaning: Employ experienced workers or professional cleaners for final cleaning. Clean each surface or unit to condition expected in an average commercial building cleaning and maintenance program. Comply with manufacturer's written instructions.
  - 1. Complete the following cleaning operations before requesting inspection for certification of Substantial Completion for entire Project or for a designated portion of Project:
    - a. Clean Project site, in areas disturbed by construction activities, of rubbish, waste material, litter, and other foreign substances.
    - b. Clean exposed interior hard-surfaced finishes to a dirt-free condition, free of stains, films, and similar foreign substances. Restore reflective surfaces to their original condition.
    - c. Remove debris and surface dust from limited access spaces,
    - d. Vacuum carpet and similar soft surfaces, removing debris and excess nap; clean according to manufacturer's recommendations if visible soil or stains remain.
    - e. Leave Project clean and ready for occupancy.

END OF SECTION 017700

## SECTION 096813 - TILE CARPETING

### PART 1 - GENERAL

#### 1.1 SUMMARY

- A. Section includes modular carpet tile.
- B. Carpet Tile shall be installed in 16 2<sup>nd</sup> and 3<sup>rd</sup> floor 4-bedroom suites (including 202, 203, 220, 221, 246, 247, 264, 265, 302, 303, 320, 321, 346, 347, 364, and 365) as well as all 2<sup>nd</sup> and 3<sup>rd</sup> floor bedrooms. No bathrooms will be receiving flooring at this time.

#### 1.2 QUALITY ASSURANCE

- A. Installer Qualifications: An experienced installer who is certified by the Flooring Covering Installation Board or who can demonstrate compliance with its certification program requirements.

#### 1.3 WARRANTY

- A. Special Warranty for Carpet Tiles: Manufacturer's standard form in which manufacturer agrees to repair or replace components of carpet tile installation that fail in materials or workmanship within specified warranty period.
  - 1. Warranty does not include deterioration or failure of carpet tile due to unusual traffic, failure of substrate, vandalism or abuse.
  - 2. Failures include but not limited to more than 10 percent loss of face fiber, edge raveling, snags, runs, loss of tuft bind strength, dimensional stability, excess static discharge and delamination.
  - 3. Warranty Period: Lifetime Commercial Limited.

### PART 2 - PRODUCTS

#### 2.1 CARPET TILE

- A. Shaw Diffuse (Basis of Design)
- B. Color: 78520 Cool Teal
- C. Style: 5T478
- D. Pattern: Quarter turn.



- E. Construction: multi-level pattern loop.
- F. Average Density: 6261 oz/yd
- G. Total Thickness: 0.230 in.
- H. Finished Pile Thickness: 0.092 in.
- I. Stitches: 8.5 per in.
- J. Gage: 1/12 in.
- K. Tufted Weight: 16 oz. / sq. yd.
- L. Size: 24.0 x 24.0 Ecworx Tile
- M. Applied Treatments:
  - 1. Soil-Resistance Treatment: Manufacturer's standard treatment.
  - 2. Antimicrobial Treatment: Manufacturer's standard treatment that protects carpet tiles as follows:
    - a. Antimicrobial Activity: Not less than 2-mm halo of inhibition for gram-positive bacteria, not less than 1-mm halo of inhibition for gram-negative bacteria, and no fungal growth, according to AATCC 174.

2.2 Cove Base: Johnsonite 6" x 1/8" cove base. Color: Charcoal. (Basis of Design)

### 2.3 INSTALLATION ACCESSORIES

- A. Trowelable Leveling and Patching Compounds: Latex-modified, hydraulic-cement-based formulation provided or recommended by carpet tile manufacturer.
- B. Adhesives: Water-resistant, mildew-resistant, nonstaining, pressure-sensitive type to suit products and subfloor conditions indicated, that comply with flammability requirements for installed carpet tile, and are recommended by carpet tile manufacturer for releasable installation.

## PART 3 - EXECUTION

### 3.1 EXAMINATION

- A. Wood Subfloors: Verify that underlayment surface is free of irregularities and substances that may interfere with adhesive bond or show through surface.

### 3.2 PREPARATION

- A. General: Comply with CRI's "CRI Carpet Installation Standards" and with carpet tile manufacturer's written installation instructions for preparing substrates indicated to receive carpet tile.
- B. Use trowelable leveling and patching compounds, according to manufacturer's written instructions, to fill cracks, holes, depressions, and protrusions in substrates. Fill or level cracks, holes and depressions 1/8 inch (3 mm) wide or wider, and protrusions more than 1/32 inch (0.8 mm) unless more stringent requirements are required by manufacturer's written instructions.
- C. Concrete Substrates: Remove coatings, including curing compounds, and other substances that are incompatible with adhesives and that contain soap, wax, oil, or silicone, without using solvents. Use mechanical methods recommended in writing by adhesive and carpet tile manufacturers.
- D. Broom and vacuum clean substrates to be covered immediately before installing carpet tile.

### 3.3 INSTALLATION

- A. General: Comply with CRI's "CRI Carpet Installation Standard," Section 18, "Modular Carpet" and with carpet tile manufacturer's written installation instructions.
- B. Installation Method: As recommended in writing by carpet tile manufacturer.
- C. Maintain dye-lot integrity. Do not mix dye lots in same area.
- D. Cut and fit carpet tile to butt tightly to vertical surfaces, permanent fixtures, and built-in furniture including cabinets, pipes, outlets, edgings, thresholds, and nosings. Bind or seal cut edges as recommended by carpet tile manufacturer.
- E. Extend carpet tile into toe spaces, door reveals, closets, open-bottomed obstructions, removable flanges, alcoves, and similar openings.
- F. Maintain reference markers, holes, and openings that are in place or marked for future cutting by repeating on carpet tile as marked on subfloor. Use nonpermanent, nonstaining marking device.
- G. Install pattern parallel to walls and borders.
- H. Protect carpet tile against damage from construction operations and placement of equipment and fixtures during the remainder of construction period. Use protection methods indicated or recommended in writing by carpet tile manufacturer.

END OF SECTION 096813

## SECTION 093013 - CERAMIC TILING

## PART 1 - GENERAL

## 1.1 SUMMARY

- A. Section Includes: Porcelain tile.
- B. Porcelain tile shall be installed in Ingle Hall lobby.

## 1.2 QUALITY ASSURANCE

- A. Source of Materials: Provide materials obtained from one source for each type and color of tile, grout and setting materials.
- B. Work shall be executed and tested in accordance with current editions of the following standards:
  - 1. ANSI® A108.1 - Installation of ceramic tile with portland cement 1. ANSI® A108.4 - Installation of ceramic tile with water resistant organic adhesives. ANSI® A108.5 - Installation of ceramic tile installed with dry-set portland cement mortar or latex-portland cement mortar. ANSI® A108.6 - Installation for ceramic tile installed with chemical-resistant epoxy.
  - 2. American Society for Testing & Material (ASTM®) ASTM C150 - Specifications for portland cement ASTM C206 - Specifications for hydrated lime
  - 3. Federal Specifications (FS)FSTT-S 001543 Class A or B (COM-NBS) One Part silicone rubber

## PART 2 - PRODUCTS

## 2.1 Glazed Porcelain Tile

- A. Florida Tile (Basis of Design)
- B. Style: Natura 6x24
- C. Color: Wilmington White
- D. Product Type: HDP Porcelain
- E. Surface Finish: Matte

2.2 Cove Base: Johnsonite 6" x 1/8" vinyl cove base. Charcoal. (Basis of Design)

### 2.3 THRESHOLDS

- A. General: Fabricate to sizes and profiles indicated or required to provide transition between adjacent floor finishes.

### 2.4 SETTING MATERIALS

A. Portland Cement Mortar Installation

1. **Materials:** Provide materials to comply with ANSI® A108.1 as required for installation method designated.
2. **Cleavage Membranes:** Polyethylene film. 4 mil. ASTM C171 Type 1.1.2.
3. **Reinforcing Mesh:** Welded wire fabric "x" 16/16 gauge.  
Dry-set portland cement: ANSI® 118.1 water retentive Portland Cement, sand and special latex additives. Latices vary considerably. Follow manufacturer's directions explicitly.
4. **Organic Adhesive:** ANSI® A136.1 Type 1 for areas requiring prolonged water resistance. Provide primer-sealer as recommended by the manufacturer.
5. **Epoxy Mortar:** ANSI® 118.3 Formula AAR-11 or high temperature resistance formula where indicated.

### 2.5 GROUT MATERIALS

1. **Commercial Portland Cement Grout:** Pre-blended compound composed of portland cement and additives formulated for the type tile installed.  
**Latex-portland grout:** Use latex additive in grout compatible with latex-portland cement mortar.  
**Dry set grout:** Portland cement and additives formulated for type of tile installed.

## PART 3 - EXECUTION

### 3.1 EXAMINATION

- A. Examine substrates, areas, and conditions where tile will be installed, with Installer present, for compliance with requirements for installation tolerances and other conditions affecting performance of the Work.
1. Verify that substrates for setting tile are firm; dry; clean; free of coatings that are incompatible with tile-setting materials, including curing compounds and other substances that contain soap, wax, oil, or silicone; and comply with flatness tolerances required by ANSI A108.01 for installations indicated.
  2. Verify that concrete substrates for tile floors comply with surface finish requirements in ANSI A108.01 for installations indicated.
- B. Proceed with installation only after unsatisfactory conditions have been corrected.

### 3.2 PREPARATION

- A. Fill cracks, holes, and depressions in concrete substrates for tile floors with trowelable leveling and patching compound specifically recommended by tile-setting material manufacturer.
- B. Blending: For tile exhibiting color variations, verify that tile has been factory blended and packaged so tile units taken from one package show same range of colors as those taken from other packages and match approved Samples. If not factory blended, either return to manufacturer or blend tiles at Project site before installing.

### 3.3 INSTALLATION STANDARDS

- A. Comply with applicable parts of ANSI<sup>®</sup> A-108 Series for ceramic tile installation.
- B. Extend tile work into recesses and under or behind equipment and fixtures to form complete covering without interruptions unless otherwise indicated. Terminate work neatly at obstructions, edges, and corners without disrupting pattern or joint alignments.
- C. Accurately form intersections and returns. Perform cutting and drilling of tile without marring visible surfaces. Carefully grind cut edges of tile abutting trim, finish, or built-in items for straight aligned joints. Fit tile closely to electrical outlets, piping, fixtures, and other penetrations so plates, collars, or covers overlap tile.
- D. Provide manufacturer's standard trim shapes where necessary to eliminate exposed tile edges.
- E. Joint Widths: Unless otherwise indicated, install tile with the following joint widths:
  - 1. Porcelain Tile: 3/8 inch (9.5 mm)
- F. Expansion Joints: Provide expansion joints and other sealant-filled joints, including control, contraction, and isolation joints, where indicated. Form joints during installation of setting materials, mortar beds, and tile. Do not saw-cut joints after installing tiles.
  - 1. Where joints occur in concrete substrates, locate joints in tile surfaces directly above them.
- G. Stone Thresholds: Install stone thresholds in same type of setting bed as adjacent floor unless otherwise indicated.
  - 1. At locations where mortar bed (thickset) would otherwise be exposed above adjacent floor finishes.
- H. Metal Edge Strips: Install where exposed edge of tile flooring meets carpet, wood, or other flooring that finishes flush with top of tile or where exposed edge of tile flooring meets carpet, wood, or other flooring that finishes flush with or below top of tile and no threshold is indicated.
- I. Floor Sealer: Apply floor sealer to grout joints according to floor-sealer manufacturer's written instructions. As soon as floor sealer has penetrated grout joints, remove excess sealer and sealer from tile faces by wiping with soft cloth.

- J. Install tile backing panels and treat joints according to ANSI A108.11 and manufacturer's written instructions for type of application indicated.

END OF SECTION 093013

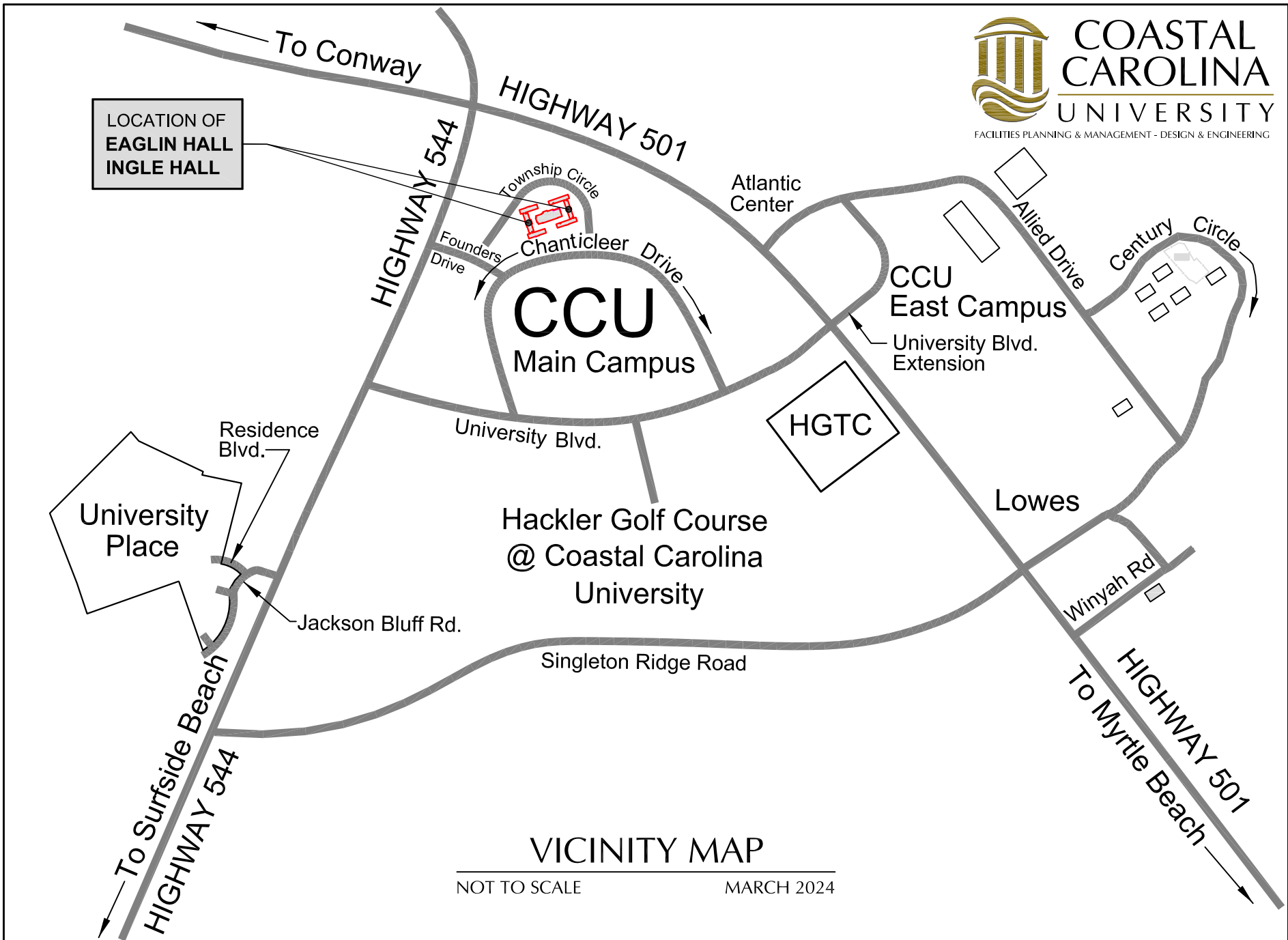

**VICINITY MAP**

NOT TO SCALE

MARCH 2024

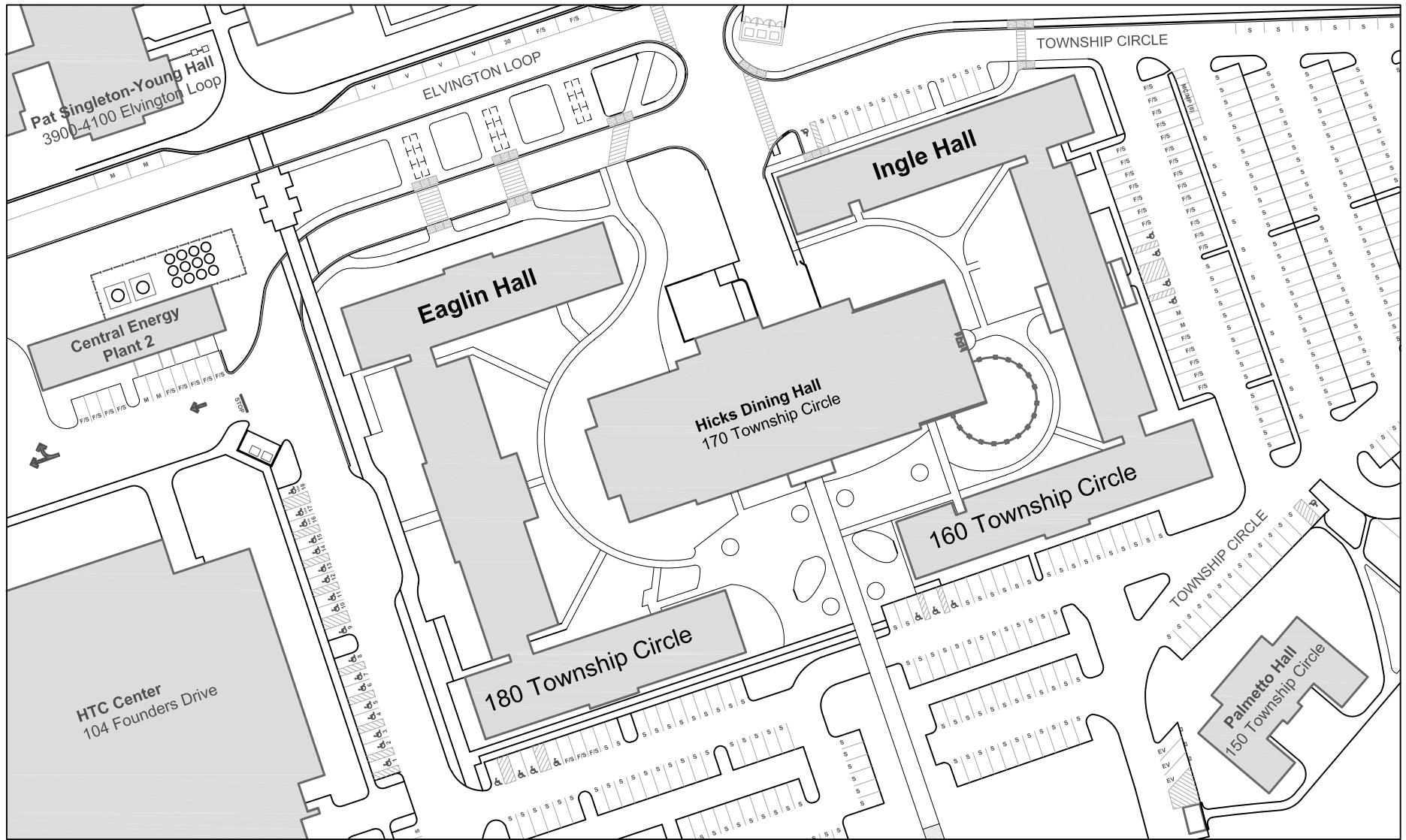

**COASTAL  
CAROLINA  
UNIVERSITY**

FACILITIES PLANNING & MANAGEMENT - DESIGN & ENGINEERING

**PARTIAL CAMPUS MAP**

NOT TO SCALE

MARCH 2024

**INGLE HALL**  
160 Township Circle

**EAGLIN HALL**  
180 Township Circle



SUITE TYPE "A" ARE THE FOLLOWING ROOM NUMBERS:  
121

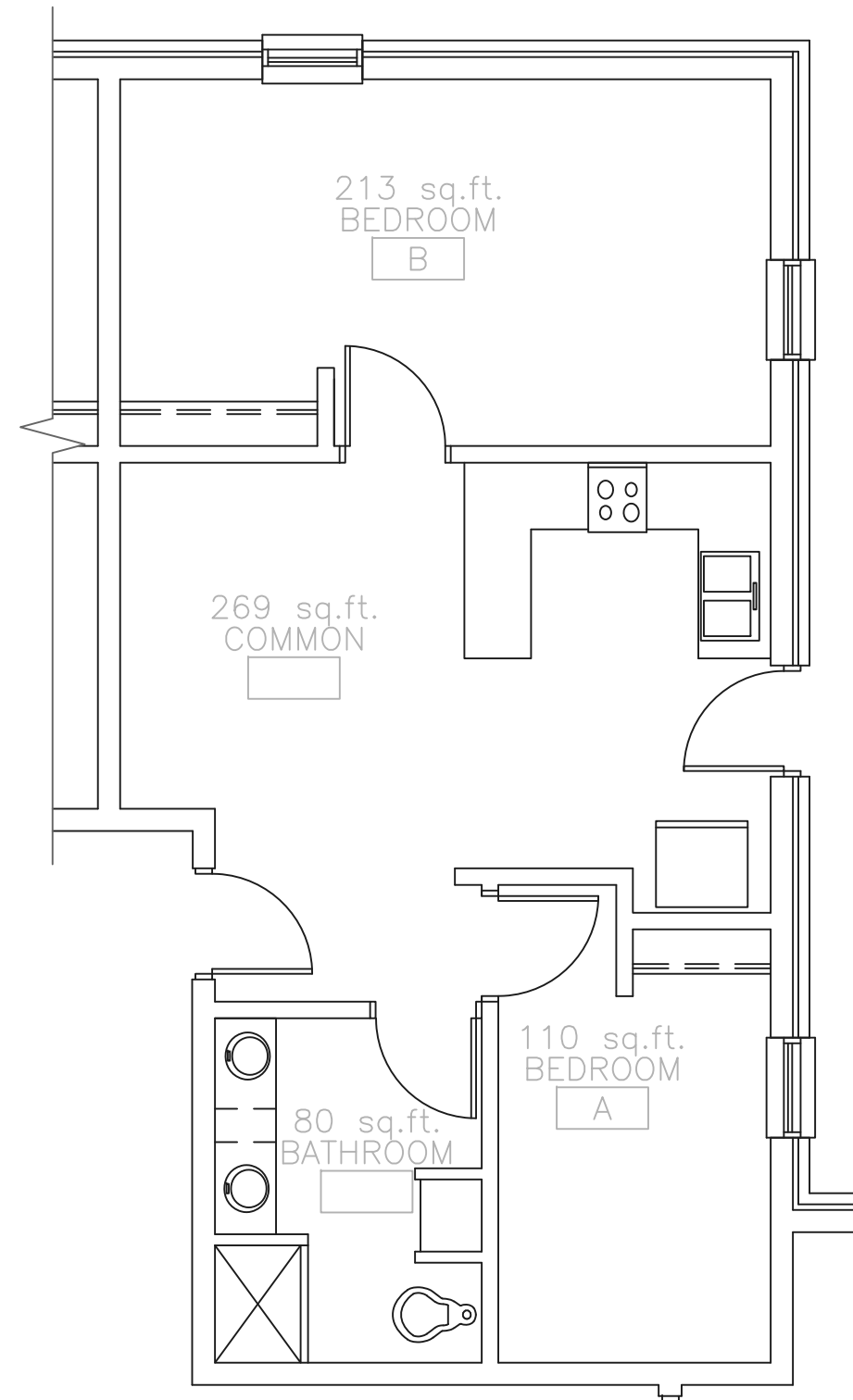

**SUITE TYPE A**  
SCALE: 3/16" = 1'-0"

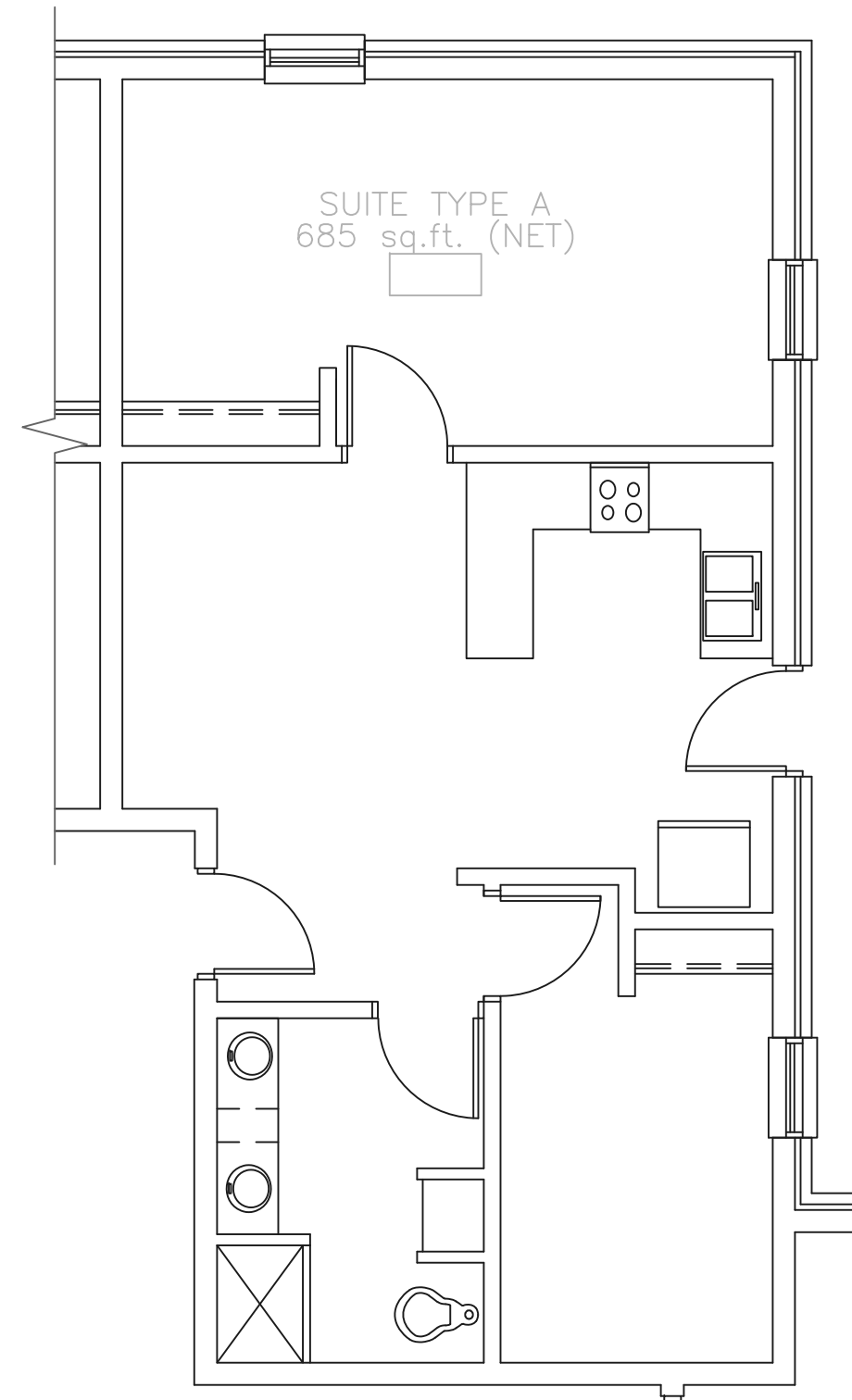

**SUITE TYPE A**  
SCALE: 3/16" = 1'-0"

SUITE TYPE "B" ARE THE FOLLOWING ROOM NUMBERS:  
164, 165  
202, 203, 264, 265  
302, 303, 364, 365

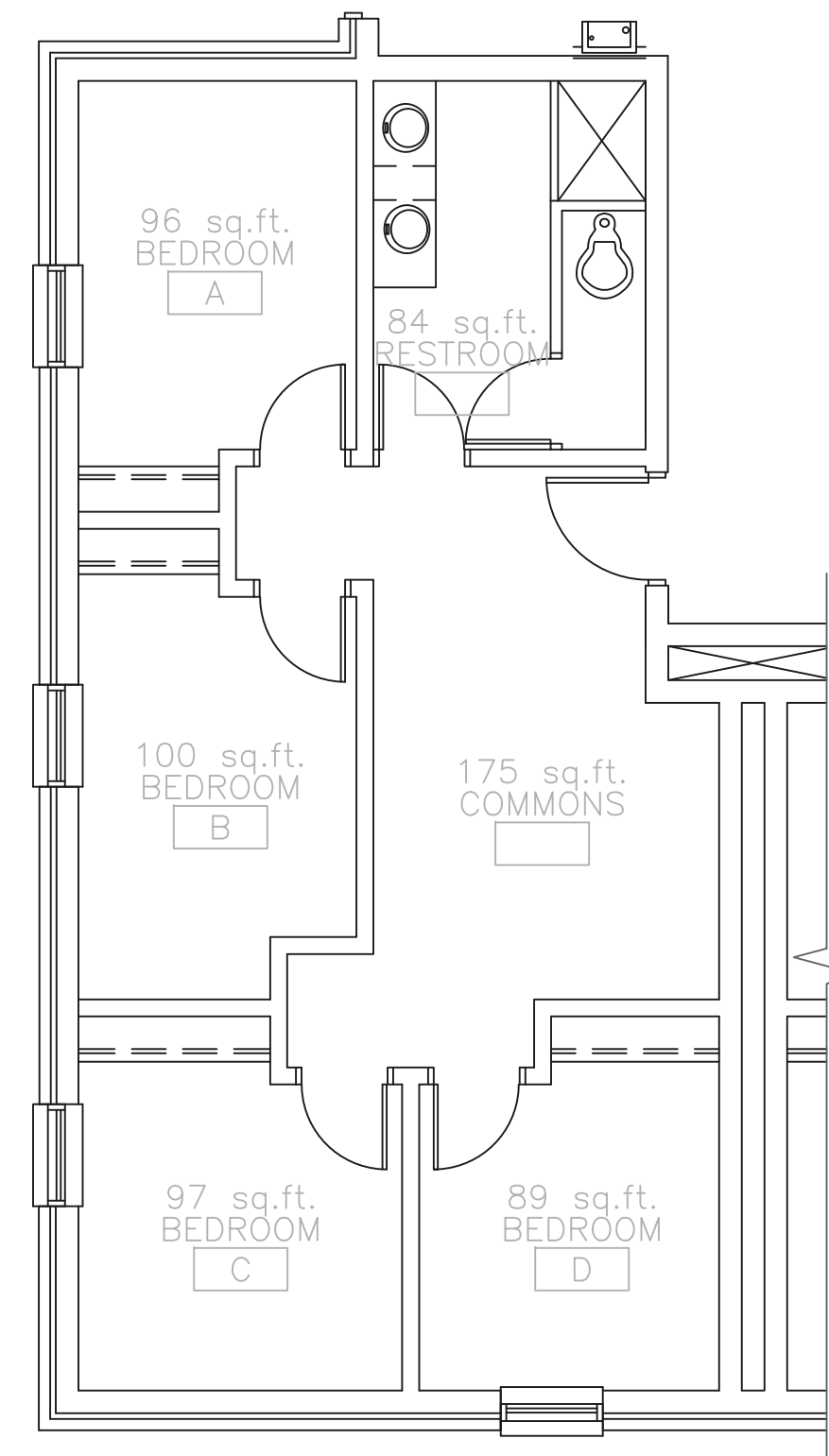

**SUITE TYPE B**  
SCALE: 3/16" = 1'-0"

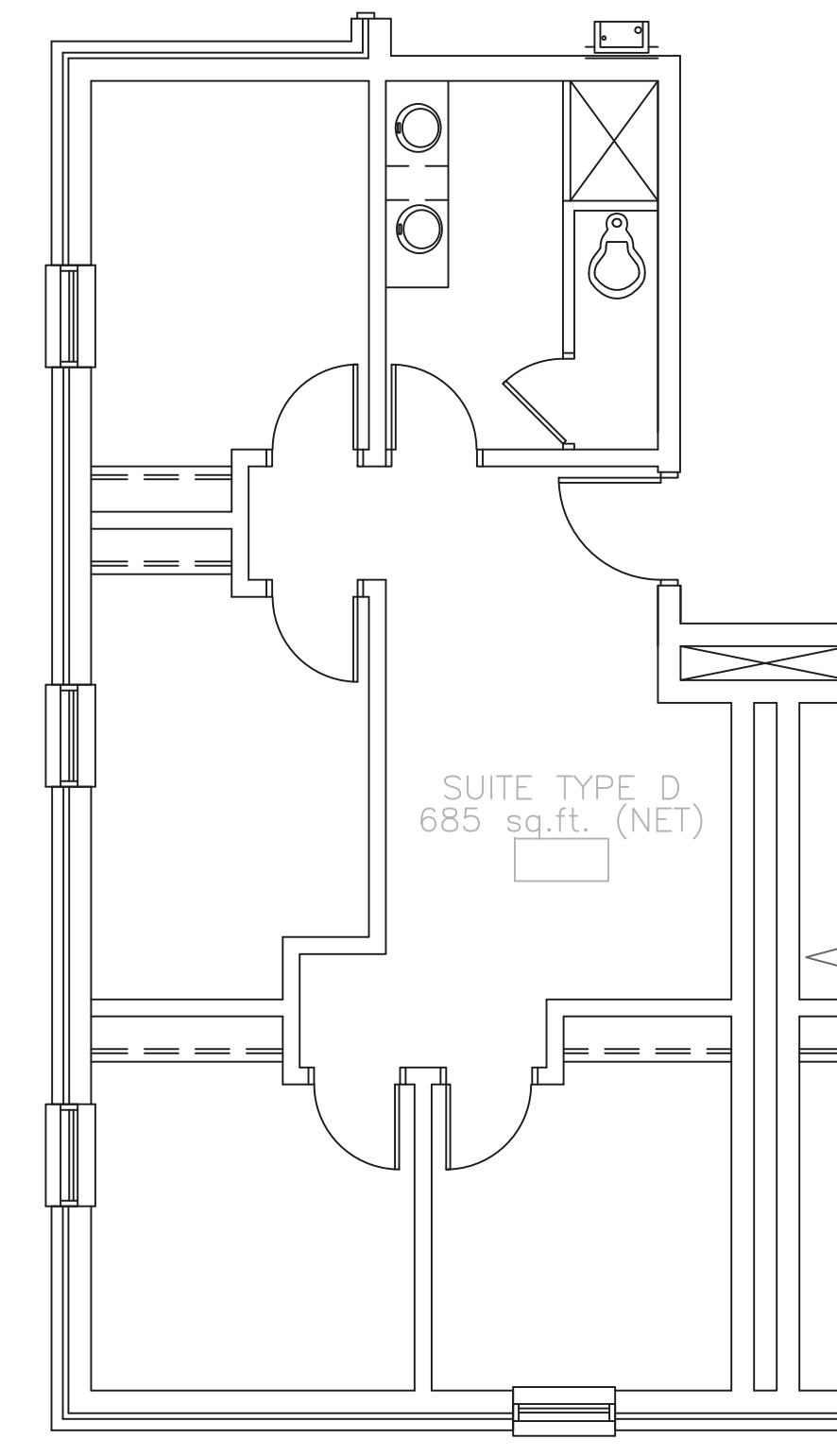

**SUITE TYPE B**  
SCALE: 3/16" = 1'-0"

SUITE TYPE "C" ARE THE FOLLOWING ROOM NUMBERS:

- 100, 101, 102, 103, 104, 105, 106, 107, 108, 108 110, 111, 112, 113, 114, 116, 117, 118, 119, 122, 123, 124, 125, 138, 139, 140, 141, 142, 143, 144, 145, 148, 149, 150, 151, 152, 153, 154\*\*, 155, 156\*\*, 157, 158, 159, 160, 161, 162, 163  
204, 205, 206, 207, 208, 209, 210, 211, 212, 213, 214, 215, 216, 217, 218, 219, 222, 223, 224, 225, 226, 227, 228, 229, 230, 231, 232\*, 234\*, 236, 237, 238, 239, 240, 241, 242, 243, 244, 245, 248, 249, 250, 251, 252, 253, 254\*\*, 255, 256\*\*, 257, 258, 259, 260, 261, 262, 263  
304, 305, 306, 307, 308, 309, 310, 311, 312, 313, 314, 315, 316, 317, 318, 319, 322, 323, 324, 325, 326, 327, 328, 329, 330, 331, 332\*, 334\*, 336, 337, 338, 339, 340, 341, 342, 343, 344, 345, 348, 349, 350, 351, 352, 353, 354\*\*, 355, 356\*\*, 357, 358, 359, 360, 361, 362, 363

NOTE 1: \*ROOMS 232, 234, 332, 334 = 222 sf EACH

NOTE 2: \*\*ROOMS 154, 156, 254, 256, 354, 356 = 245 sf EACH

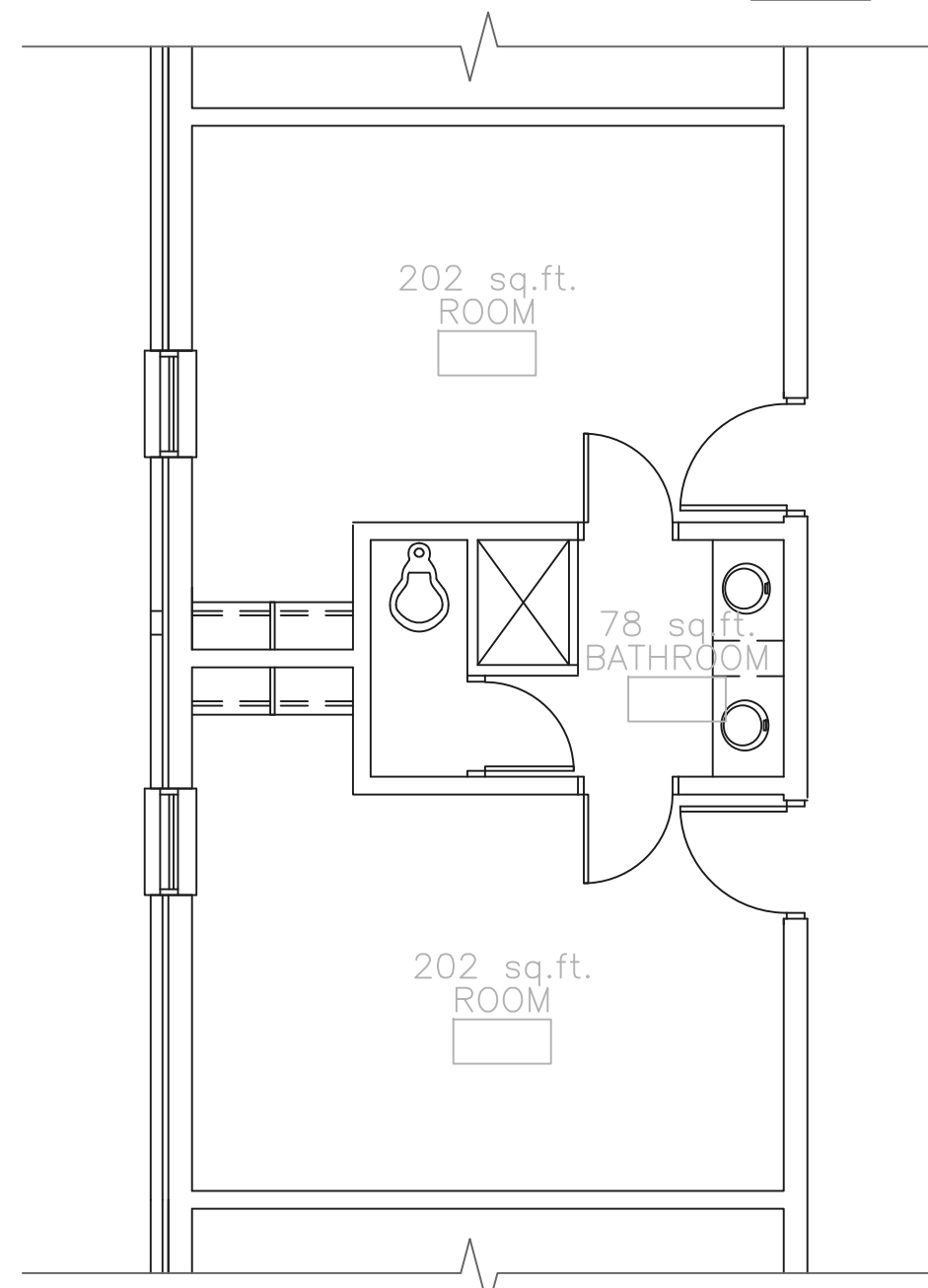

**SUITE TYPE C**  
SCALE: 3/16" = 1'-0"

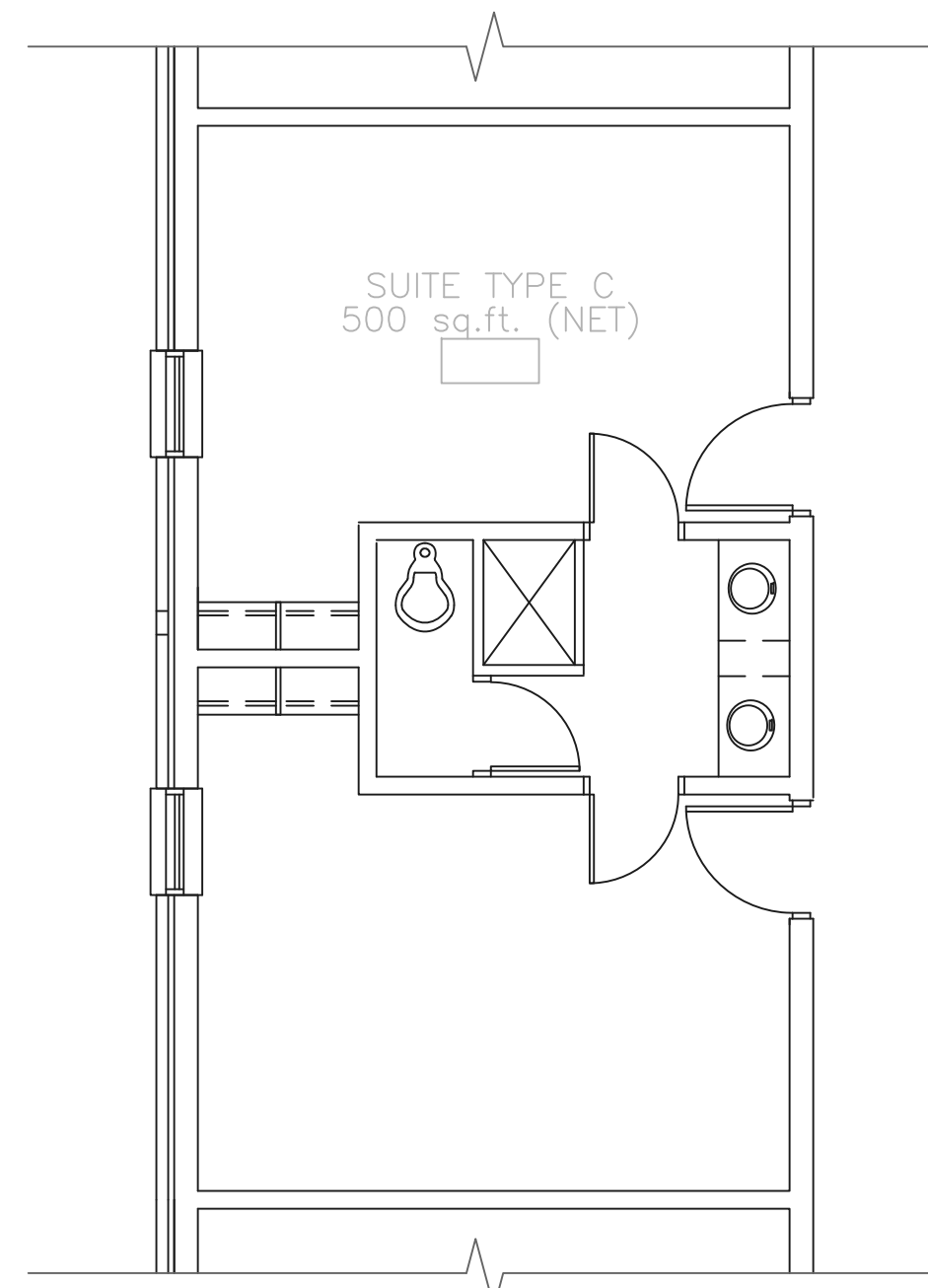

**SUITE TYPE C**  
SCALE: 3/16" = 1'-0"

SUITE TYPE "B" ARE THE FOLLOWING ROOM NUMBERS:

- 120, 146, 147  
220, 221, 246, 247  
320, 321, 346, 347

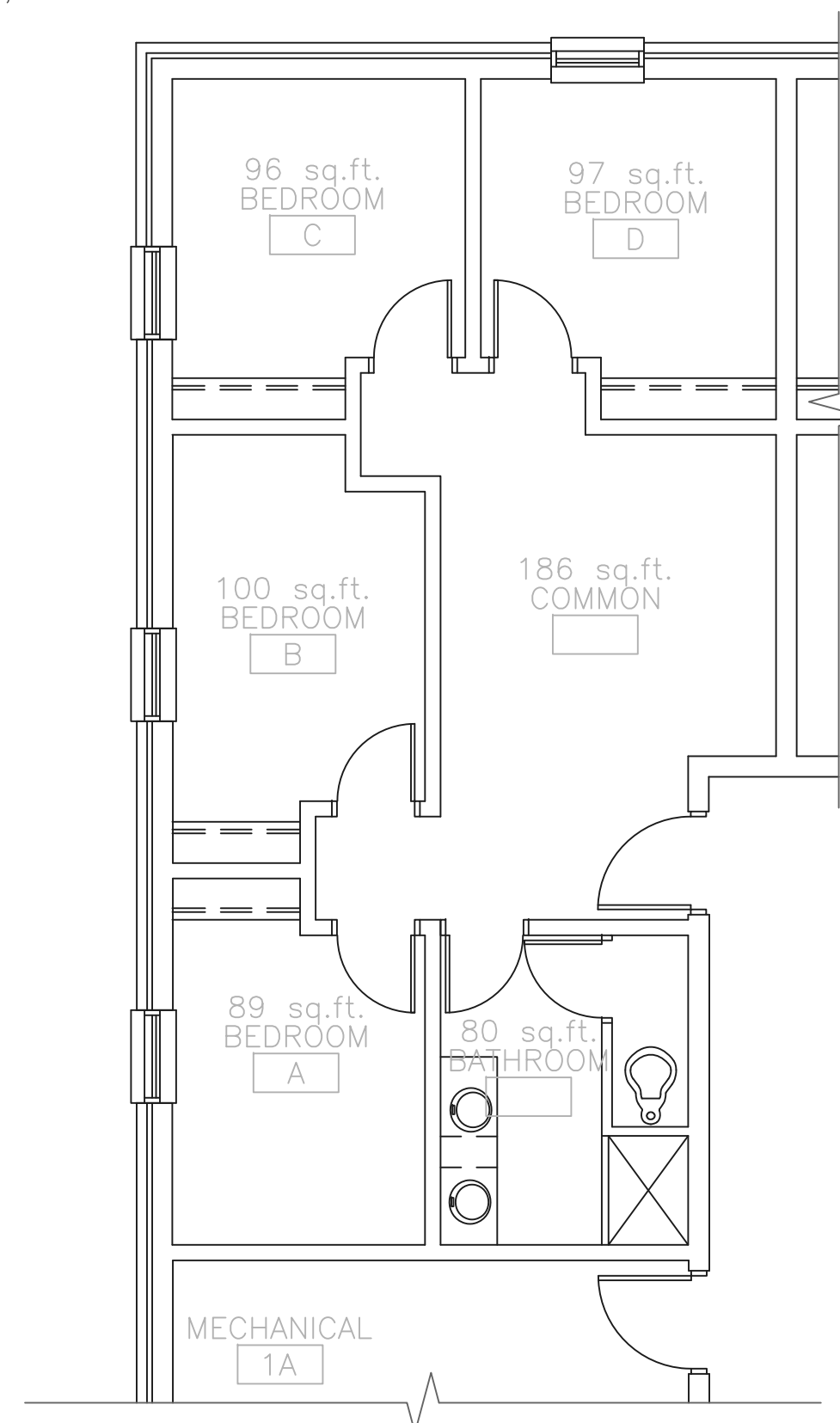

**SUITE TYPE D**  
SCALE: 3/16" = 1'-0"

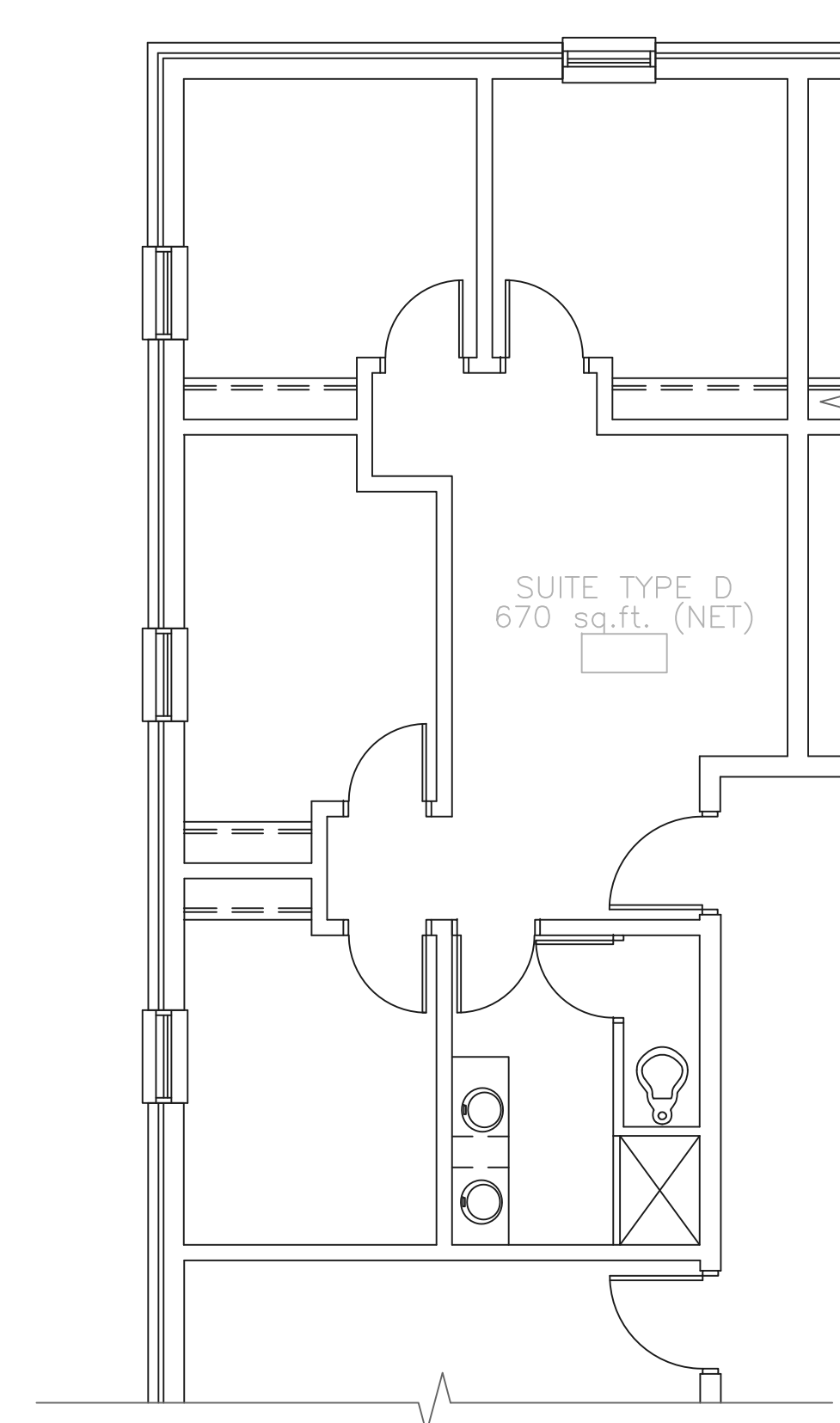

**SUITE TYPE D**  
SCALE: 3/16" = 1'-0"

SUITE TYPE NOTE: ALL SUITE TYPE ROOM LAYOUTS SHOULD BE FIELD VERIFIED PRIOR TO BID

REVISION	DATE
ADDED 2nd & 3rd FLOOR ROOM NUMBERS TO SUITE TYPE LIST	3-11-2024

BUILDING CODE IDENTIFICATION NUMBER - 285  
ENLARGED SUITE DETAILS  
RONALD R. INGLE HALL DORMITORY  
FACILITIES DESIGN & ENGINEERING

FACILITIES DESIGN & ENGINEERING  
P.O. BOX 261954  
CONWAY, SC 29528  
160 Township Circle  
Conway, SC 29528

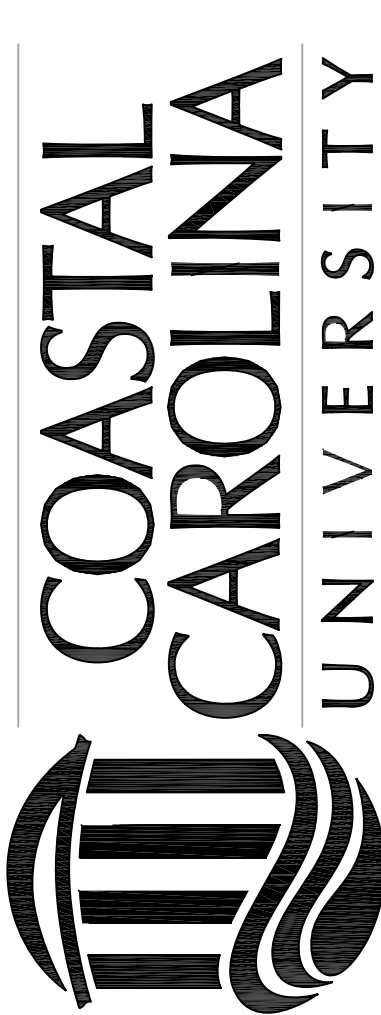

SEAL

DATE: 01-02-2013  
SCALE: SEE DWG.  
DESIGN BY: CCU  
DRAWN BY: MJT  
SHEET

REVISION	DATE
ADDED FRONT DESK	9-27-2019

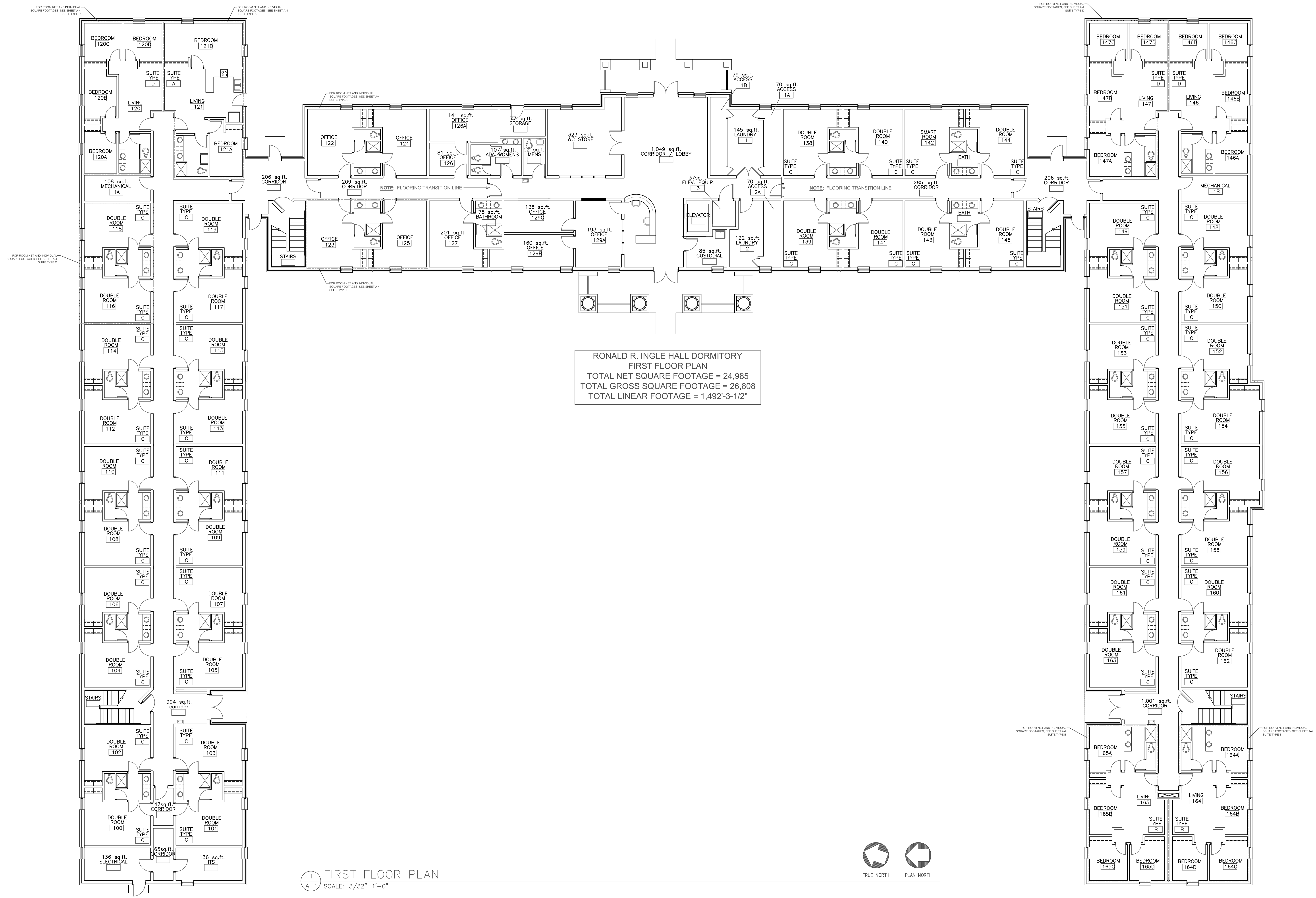

RONALD R. INGLE HALL DORMITORY  
 FIRST FLOOR PLAN  
 TOTAL NET SQUARE FOOTAGE = 24,985  
 TOTAL GROSS SQUARE FOOTAGE = 26,808  
 TOTAL LINEAR FOOTAGE = 1,492'-3-1/2"

1 FIRST FLOOR PLAN  
 A-1 SCALE: 3/32"=1'-0"

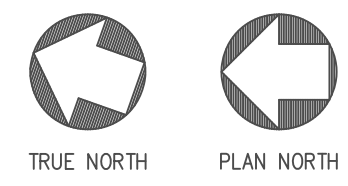

BUILDING CODE IDENTIFICATION NUMBER - 285  
 FIRST FLOOR PLAN  
 RONALD R. INGLE HALL DORMITORY  
 FACILITIES DESIGN & ENGINEERING

FACILITIES DESIGN & ENGINEERING  
 P.O. BOX 261954  
 CONWAY, SC 29528  
 160 Township Circle  
 Conway, SC 29528

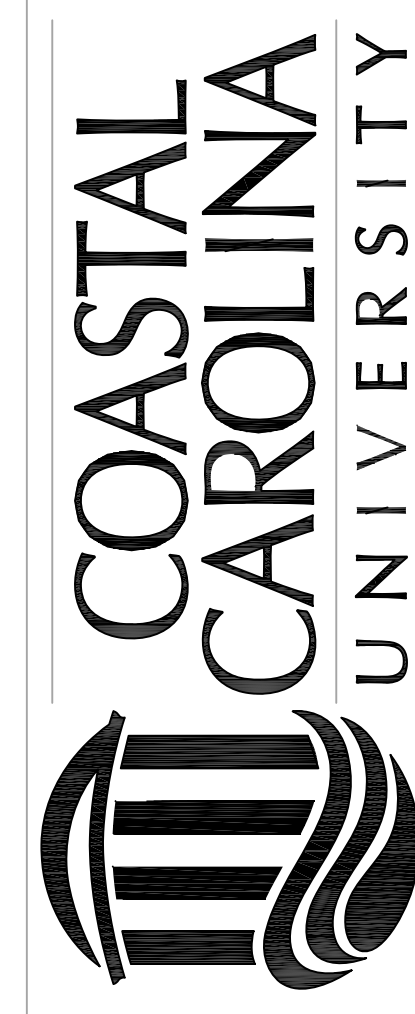

SEAL

DATE: 01-02-2013  
 SCALE: SEE DWG.  
 DESIGN BY: CCU  
 DRAWN BY: MJT  
 SHEET

A-1

REVISION	DATE

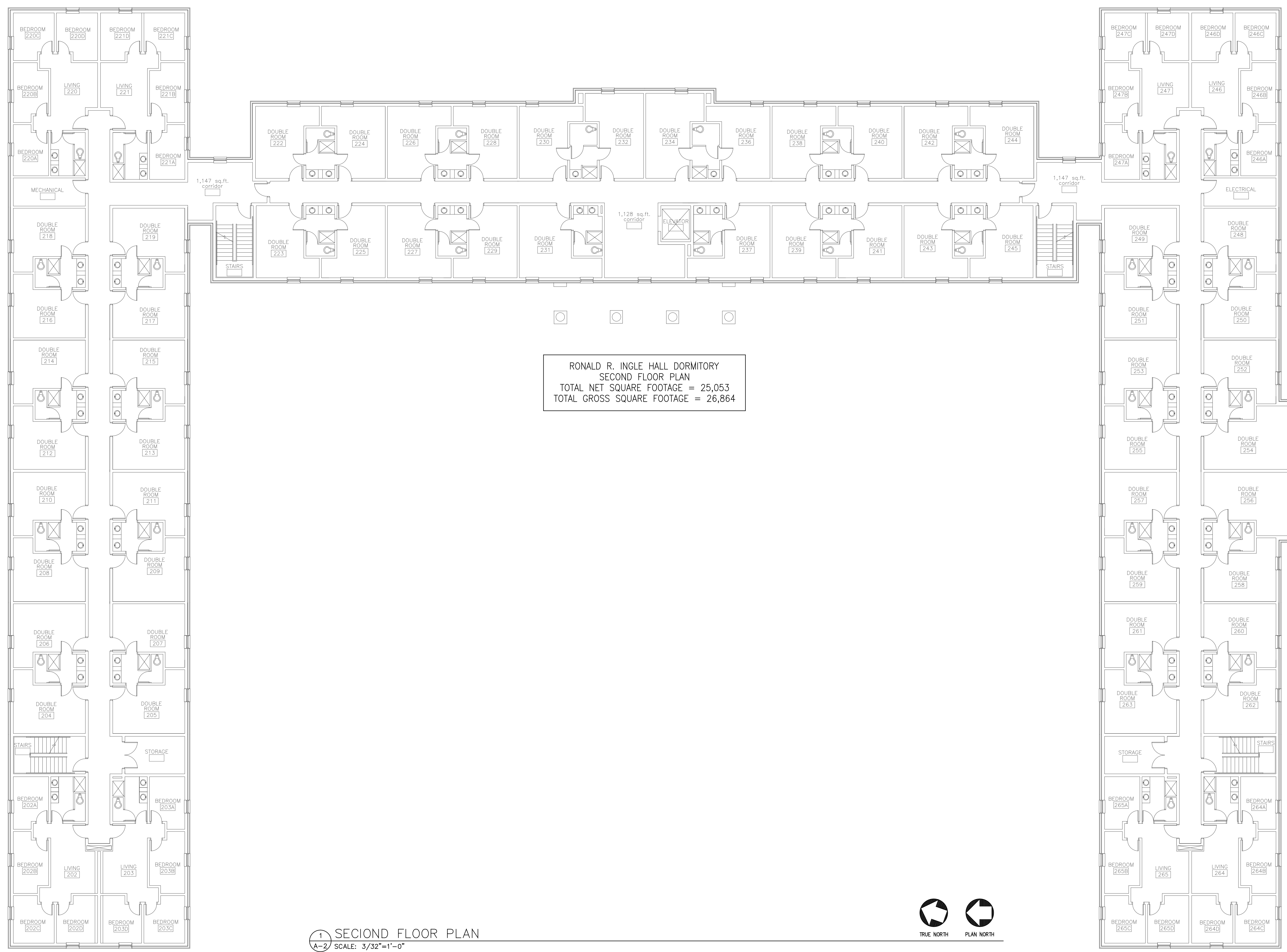

RONALD R. INGLE HALL DORMITORY  
 SECOND FLOOR PLAN  
 TOTAL NET SQUARE FOOTAGE = 25,053  
 TOTAL GROSS SQUARE FOOTAGE = 26,864

1 SECOND FLOOR PLAN  
 A-2 SCALE: 3/32"=1'-0"

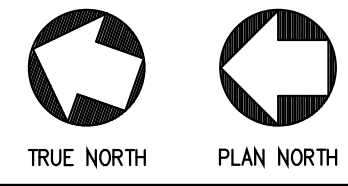

BUILDING CODE IDENTIFICATION NUMBER - 285  
 SECOND FLOOR PLAN  
 RONALD R. INGLE HALL DORMITORY  
 FACILITIES DESIGN & ENGINEERING

FACILITIES DESIGN &  
 ENGINEERING  
 P.O. BOX 261954  
 CONWAY, SC 29528  
 160 Township Circle  
 Conway, SC 29528

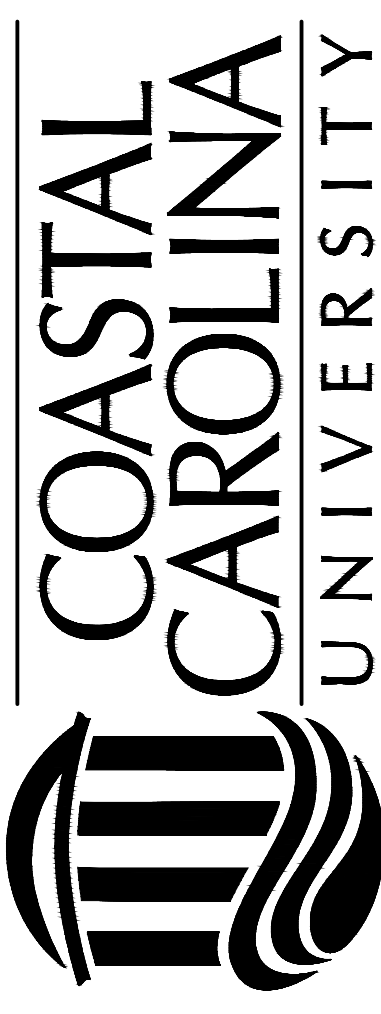

SEAL

DATE: 01-02-2013  
 SCALE: SEE DWG.  
 DESIGN BY: CCU  
 DRAWN BY: MJT  
 SHEET

A-2  
 OF 3

REVISION	DATE

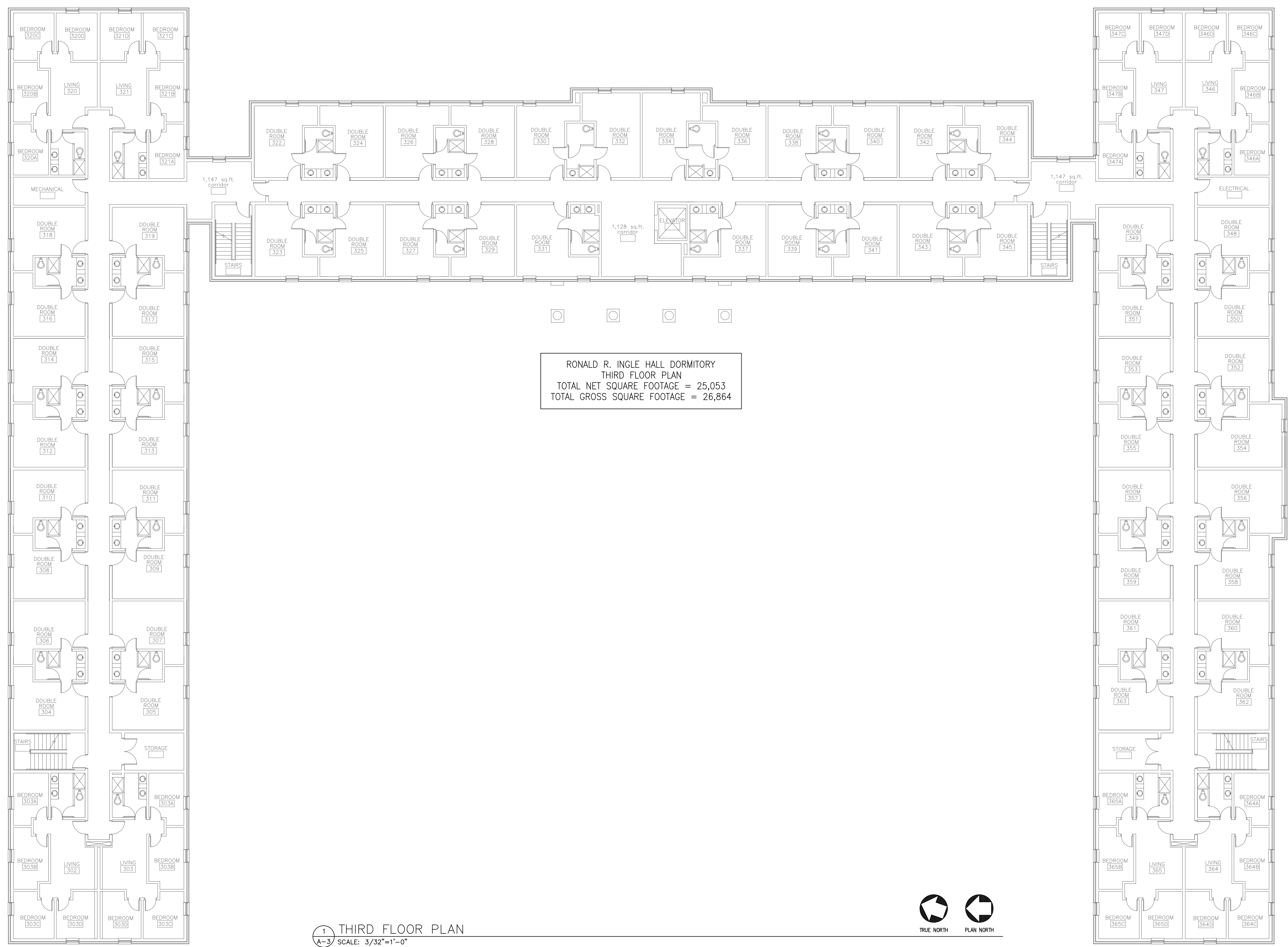

RONALD R. INGLE HALL DORMITORY  
 THIRD FLOOR PLAN  
 TOTAL NET SQUARE FOOTAGE = 25,053  
 TOTAL GROSS SQUARE FOOTAGE = 26,864

1 THIRD FLOOR PLAN  
 A-3 SCALE: 3/32"=1'-0"

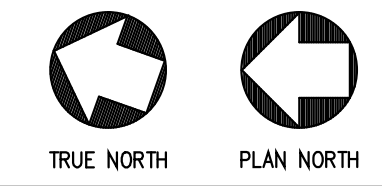

BUILDING CODE IDENTIFICATION NUMBER - 285  
 THIRD FLOOR PLAN  
 Ronald R. Ingle Hall Dormitory  
 FACILITIES DESIGN & ENGINEERING

FACILITIES DESIGN &  
 ENGINEERING  
 P.O. BOX 261954  
 CONWAY, SC 29528  
 160 Township Circle  
 Conway, SC 29528



SEAL

DATE: 01-02-2013  
 SCALE: SEE DWG.  
 DESIGN BY: CCU  
 DRAWN BY: MJT

SHEET  
**A-3**  
 OF 3